

**ROTEL**

# Owner's Manual

## RSX-1055 Surround Sound Receiver







**CAUTION**  
RISK OF ELECTRIC SHOCK  
DO NOT OPEN



**CAUTION: TO REDUCE THE RISK OF ELECTRIC SHOCK, DO NOT REMOVE COVER. NO USER-SERVICEABLE PARTS INSIDE. REFER SERVICING TO QUALIFIED SERVICE PERSONNEL.**



**This symbol is to alert the user to the presence of uninsulated dangerous voltages inside the product's enclosure that may constitute a risk of electric shock.**



**This symbol is to alert the user to important operating and maintenance (service) instructions in this manual and literature accompanying the product.**

**APPLICABLE FOR USA, CANADA OR WHERE APPROVED FOR THE USAGE**

**CAUTION: TO PREVENT ELECTRIC SHOCK, MATCH WIDE BLADE OF PLUG TO WIDE SLOT. INSERT FULLY.**

**ATTENTION: POUR EVITER LES CHOCS ELECTRIQUES, INTRODUIRE LA LAME LA PLUS LARGE DE LA FICHE DANS LA BORNE CORRESPONDANTE DE LA PRISE ET POUSSER JUSQU'AU FOND.**

**This Class B digital apparatus complies with Canadian ICES-003.**

---

**Cet appareil numérique de la classe B est conforme à la norme NMB-003 du Canada.**



## Notice

The **COMPUTER I/O connection** should be handled by authorized person only.

### FCC Information

This equipment has been tested and found to comply with the limits for a Class B digital device, pursuant to Part 15 of the FCC Rules. These limits are designed to provide reasonable protection against harmful interference in a residential installation. This equipment generates, uses and can radiate radio frequency energy and, if not installed and used in accordance with the instruction, may cause harmful interference to radio communications.

However, there is no guarantee that interference will not occur in a particular installation. If this equipment does cause harmful interference to radio or television reception, which can be determined by turning the equipment off and on, the user is encouraged to try to correct the interference by one or more of the following measures:

- Reorient or relocate the receiving antenna.(TV, radio, etc.)
- Increase the separation between the equipment and receiver
- Connect the equipment to an outlet on circuit different from that to which the receiver is connected.
- Consult the dealer or an experienced radio/TV technician for additional help.

### Caution

This device complies with part 15 of the FCC Rules operation is subject to the following to conditions: (1) This device may not cause harmful interference, and (2) this device must accept any interference received, including interference that may cause undesired operation.

**ANTENNA GROUNDING ACCORDING TO NATIONAL ELECTRICAL CODE INSTRUCTIONS ARTICLE 810: "RADIO AND TELEVISION EQUIPMENT"**

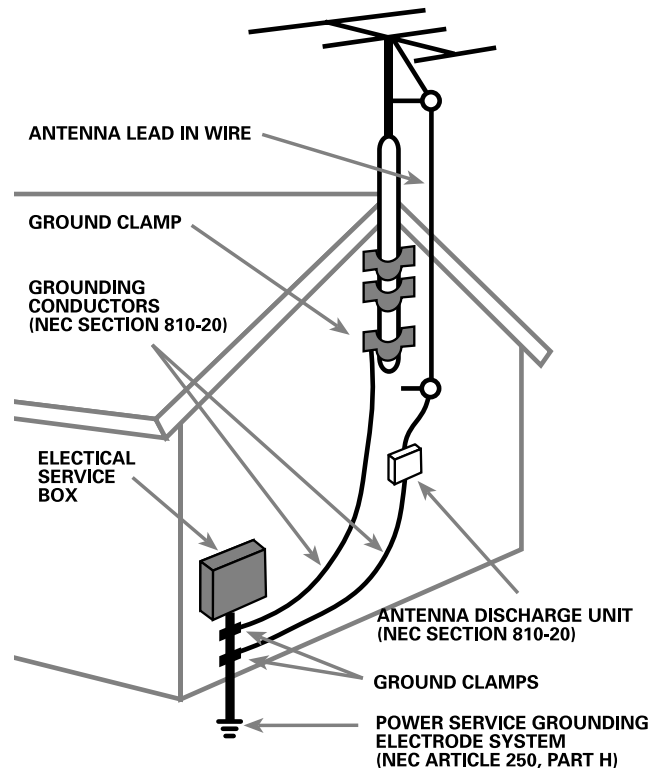

# Important Safety Instructions

**WARNING: There are no user serviceable parts inside. Refer all servicing to qualified service personnel.**

**WARNING: To reduce the risk of fire or electric shock, do not expose the unit to moisture or water. Do not allow foreign objects to get into the enclosure. If the unit is exposed to moisture, or a foreign object gets into the enclosure, immediately disconnect the power cord from the wall. Take the unit to a qualified service person for inspection and necessary repairs.**

Read all the instructions before connecting or operating the component. Keep this manual so you can refer to these safety instructions.

Heed all warnings and safety information in these instructions and on the product itself. Follow all operating instructions.

Clean the enclosure only with a dry cloth or a vacuum cleaner.

You must allow 10 cm or 4 inches of unobstructed clearance around the unit. Do not place the unit on a bed, sofa, rug, or similar surface that could block the ventilation openings. If the unit is placed in a bookcase or cabinet, there must be ventilation of the cabinet to allow proper cooling.

Keep the component away from radiators, heat registers, stoves, or any other appliance that produces heat.

The unit must be connected to a power supply only of the type and voltage specified on the rear panel. (USA: 115 V/60Hz, EC: 230V/50Hz)

Connect the component to the power outlet only with the supplied power supply cable or an exact equivalent. Do not modify the supplied cable. Do not defeat grounding and/or polarization provisions. The cable should be connected to a 2-pin polarized wall outlet, matching the wide blade of the plug to the wide slot of the receptacle. Do not use extension cords.

Do not route the power cord where it will be crushed, pinched, bent, exposed to heat, or damaged in any way. Pay particular attention to the power cord at the plug and where it exits the back of the unit.

The power cord should be unplugged from the wall outlet if the unit is to be left unused for a long period of time.

Immediately stop using the component and have it inspected and/or serviced by a qualified service agency if:

- The power supply cord or plug has been damaged.
- Objects have fallen or liquid has been spilled into the unit.
- The unit has been exposed to rain.
- The unit shows signs of improper operation
- The unit has been dropped or damaged in any way

**NOTE TO CATV SYSTEM INSTALLER:** Call the CATV system or antenna installer's attention to Article 820-40 of the NEC. This provides guidelines for proper grounding and, in particular, specifies that the cable ground shall be connected to the grounding system of the building, as close to the point of cable entry as practical. See installation diagram.

**NOTE:** This equipment has been tested and found to comply with the limits for a Class B digital device, pursuant to Part 15 of the FCC Rules. These limits are designed to provide reasonable protection against interference in a residential installation. This equipment generates and can radiate radio frequency energy and, if not installed and used in accordance with the instructions, may cause interference to radio or TV communications. There is no guarantee that interference will not occur in a particular installation. If this equipment does cause interference to radio or television reception, which can be determined by turning the equipment off and on, try to correct the interference by one or more of the following measures:

- Reorient or relocate the receiving antenna.
- Increase the separation between the unit and the television tuner.
- Connect the unit to an AC power outlet on a different electrical circuit.
- Consult your authorized Rotel retailer for assistance.

**1: Controls and Connections**

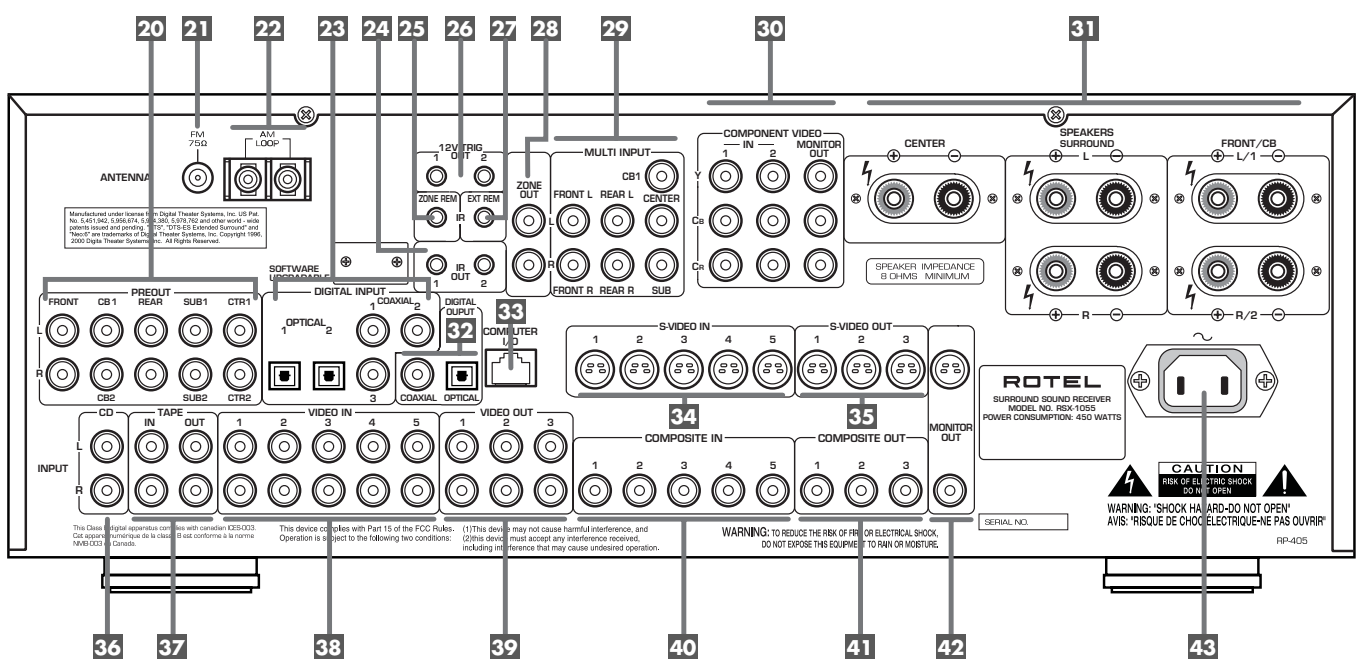
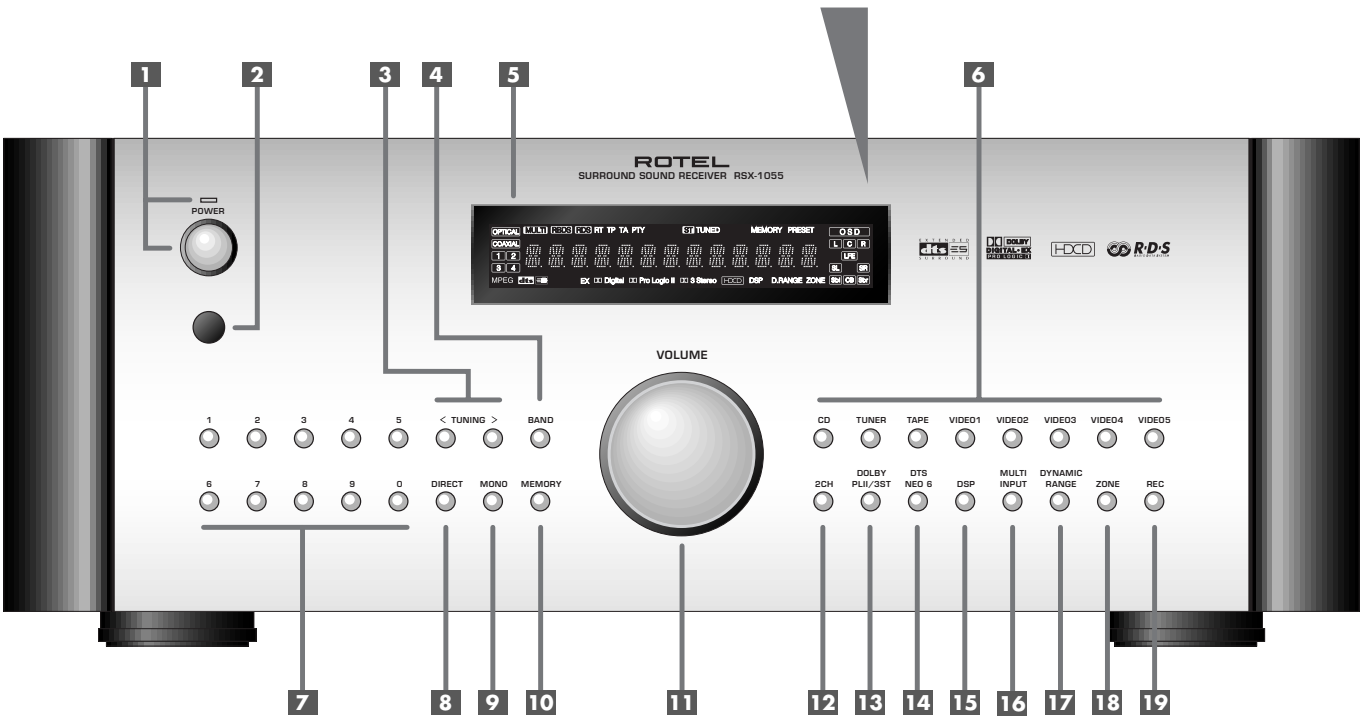

Manufactured under license by Digital Theater Systems, Inc. US Pat. Nos. 5,451,042, 5,956,674, 5,720,130, 5,379,750 and other works, and certain names and markings, such as "DTS" and "Dolby Surround" are trademarks of Digital Theater Systems, Inc. Copyright 1999, 2000 Digital Theater Systems, Inc. All Rights Reserved.

This Class 1 digital apparatus does not exceed the limits for radio frequency interference as defined in Part 15 of the FCC Rules. Operation is subject to the following two conditions: (1) This device may not cause harmful interference, and must accept any interference received, including that which may cause undesired operation.

WARNING: TO REDUCE THE RISK OF FIRE OR ELECTRICAL SHOCK, DO NOT EXPOSE THE EQUIPMENT TO RAIN OR MOISTURE.

**CAUTION**  
RISK OF ELECTRIC SHOCK  
DO NOT OPEN  
WARNING: "SHOCK HAZARD-DO NOT OPEN"  
AVIS: "RISQUE DE CHOC ELECTRIQUE-NE PAS OUVRIR"

SERIAL NO.

RP-405

2: RR-969 Remote

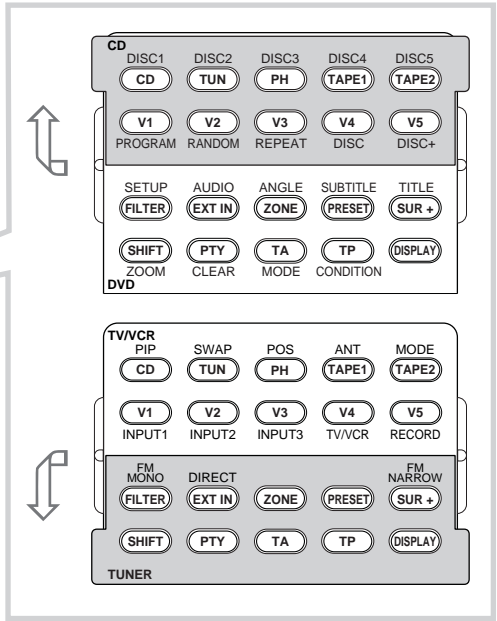
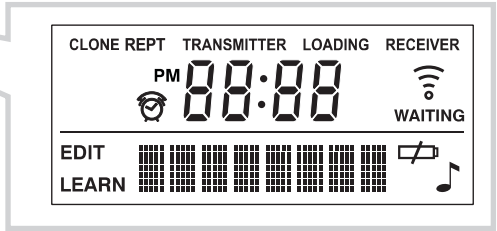
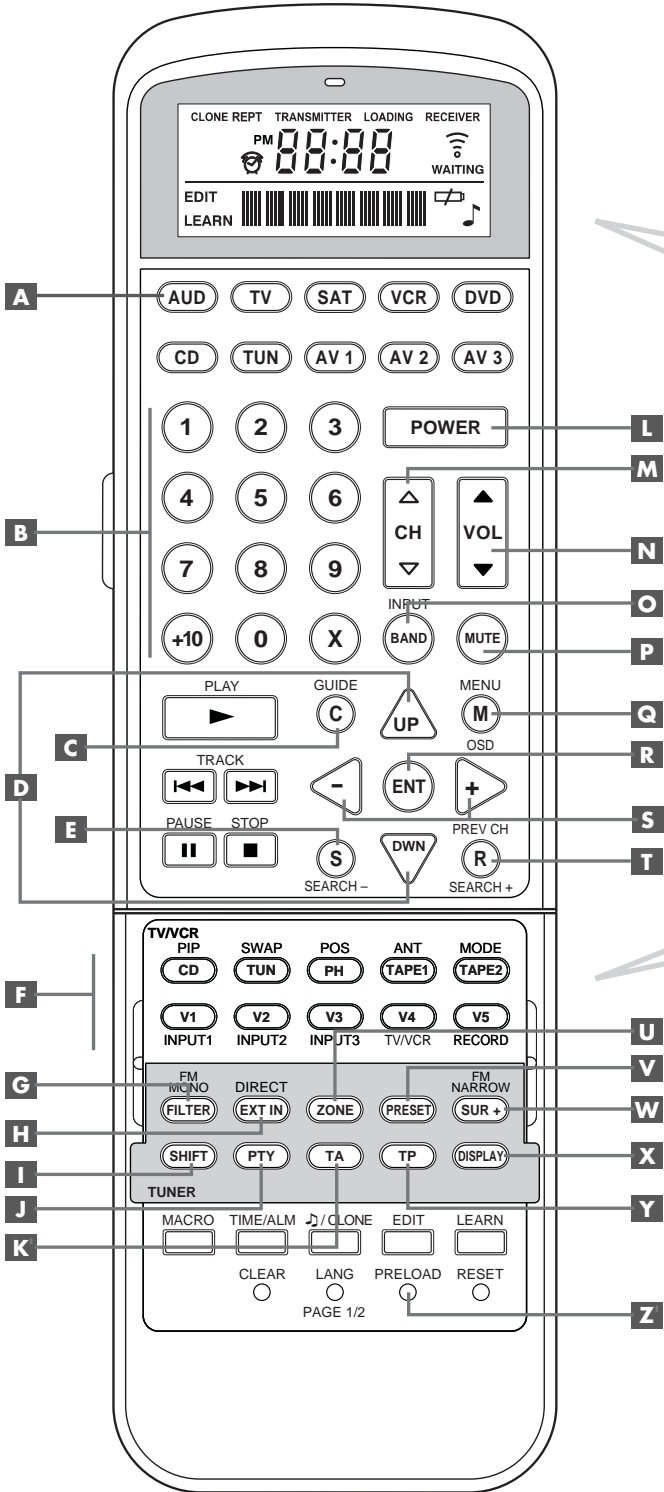

**3: Outputs**

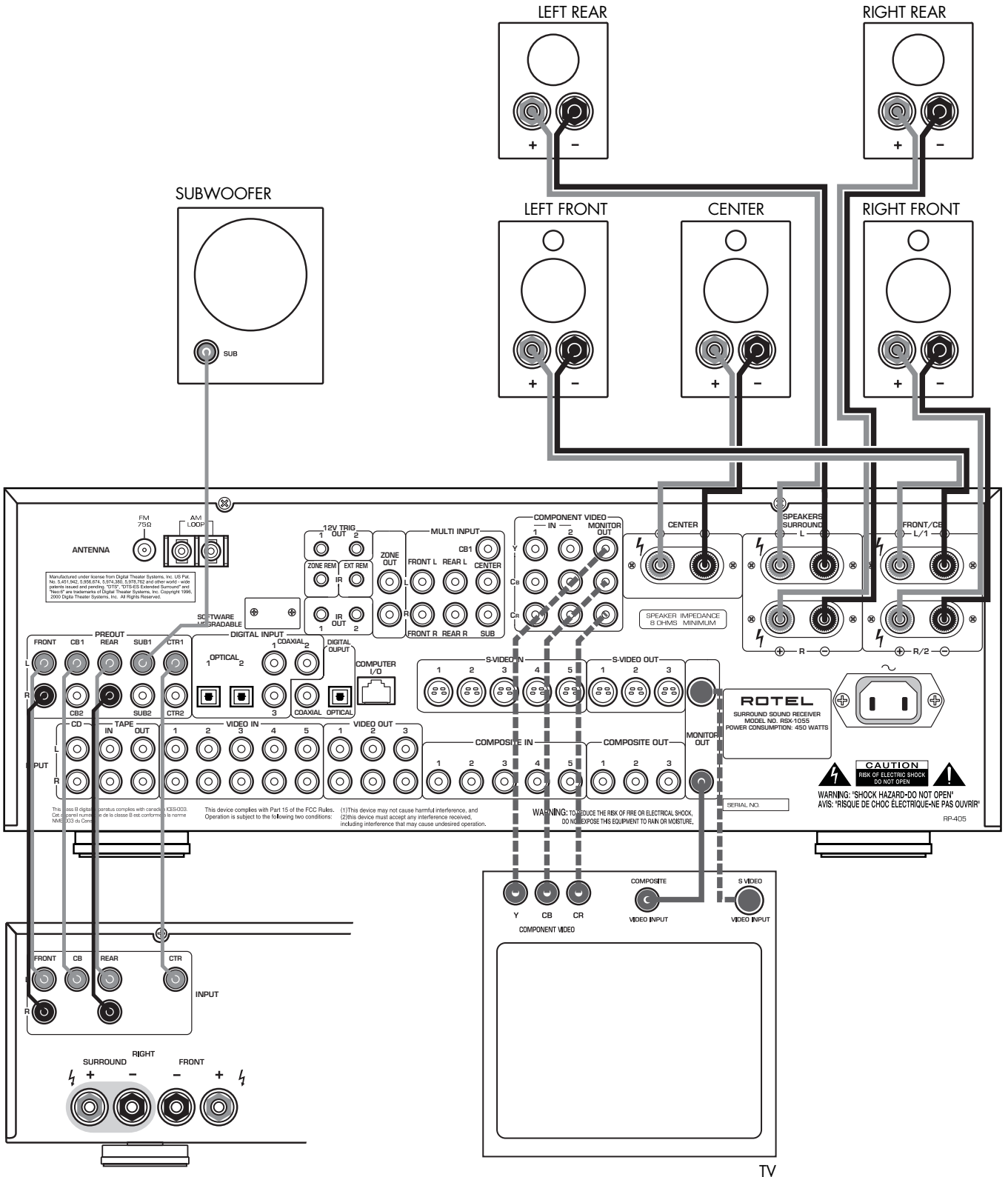

### 4: Source Connections

DVD

ROTEL RSX-1055

VCR

TAPE

CD

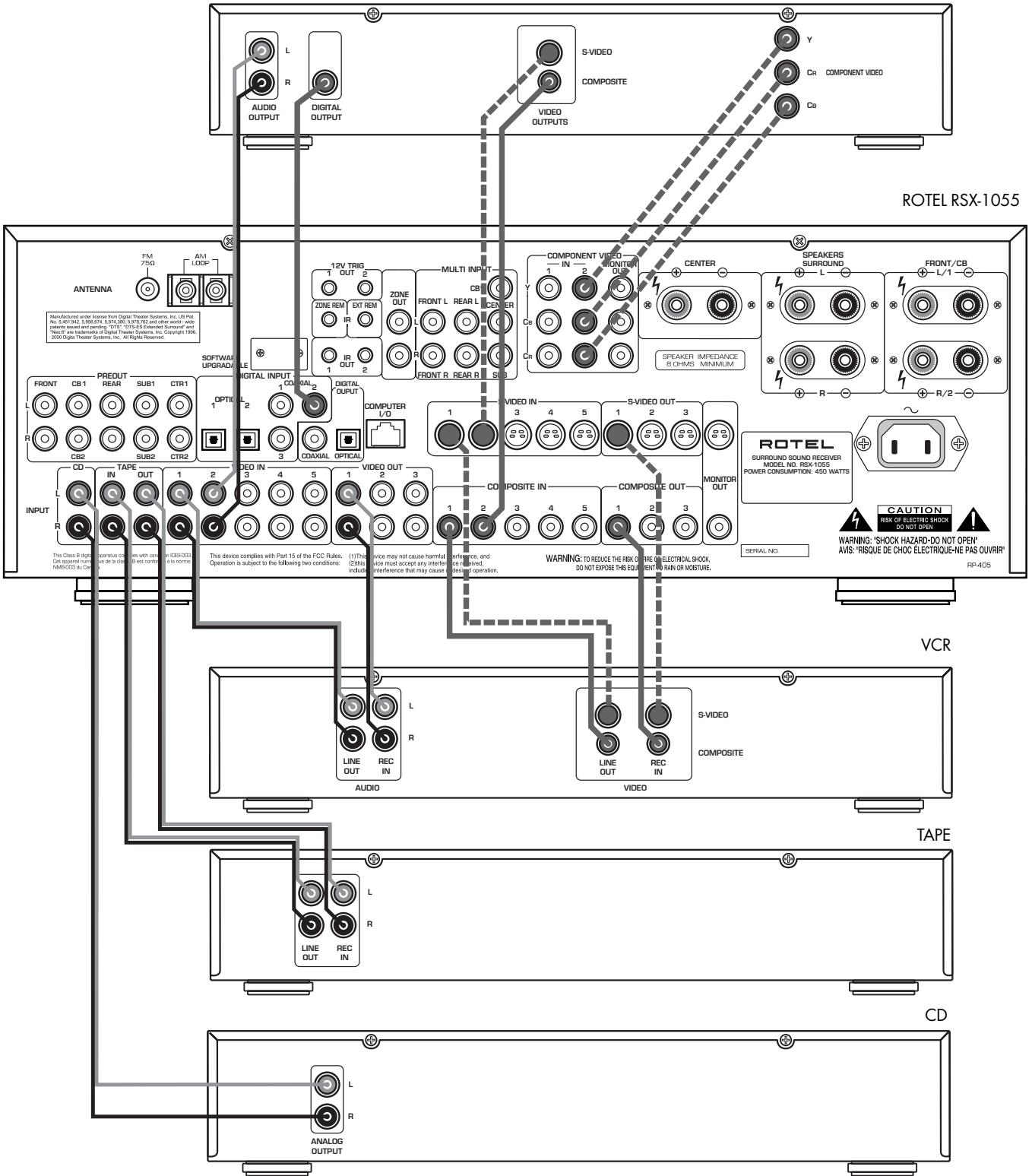

5: Zone 2 Connections

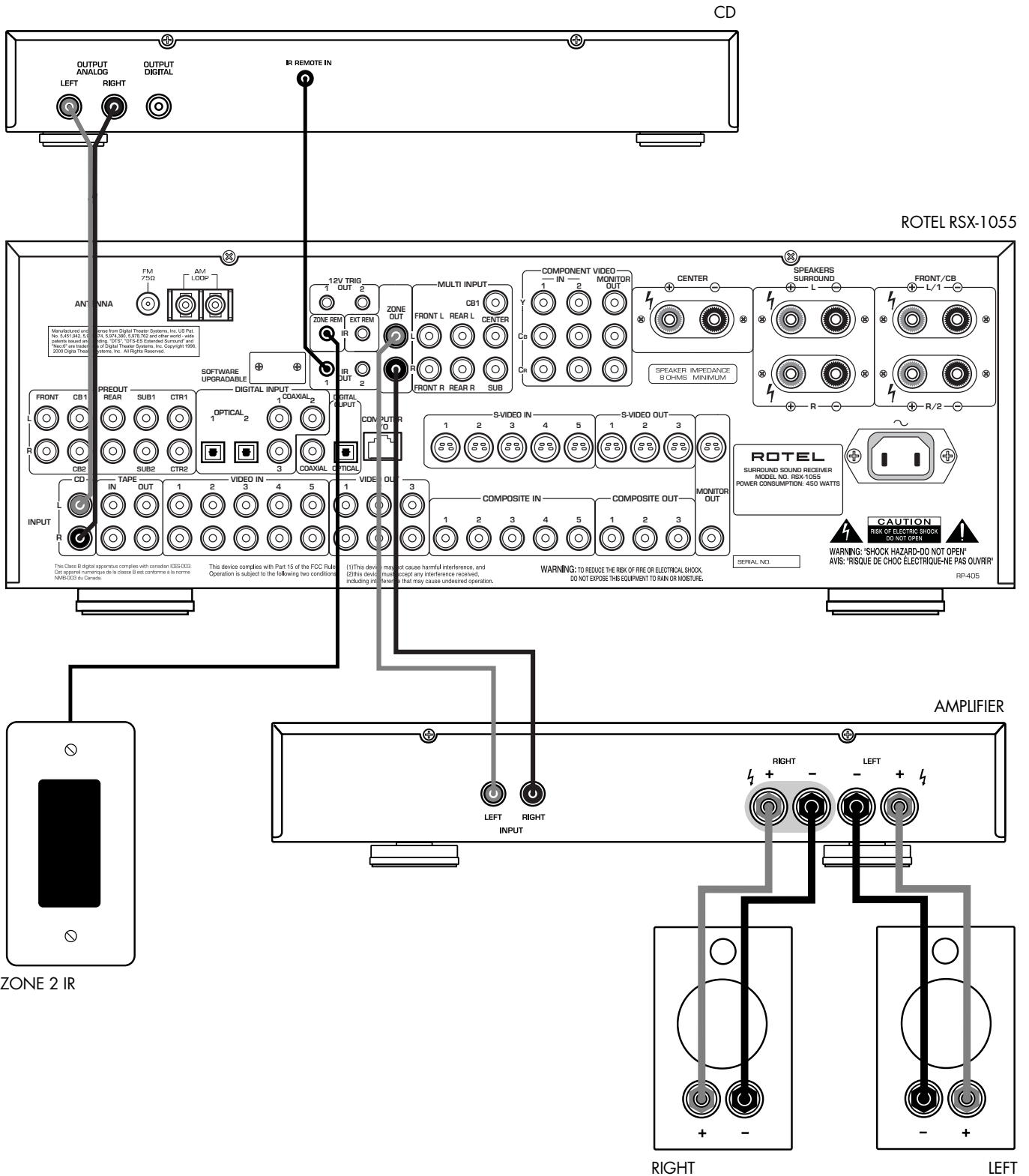



## 6: Antenna

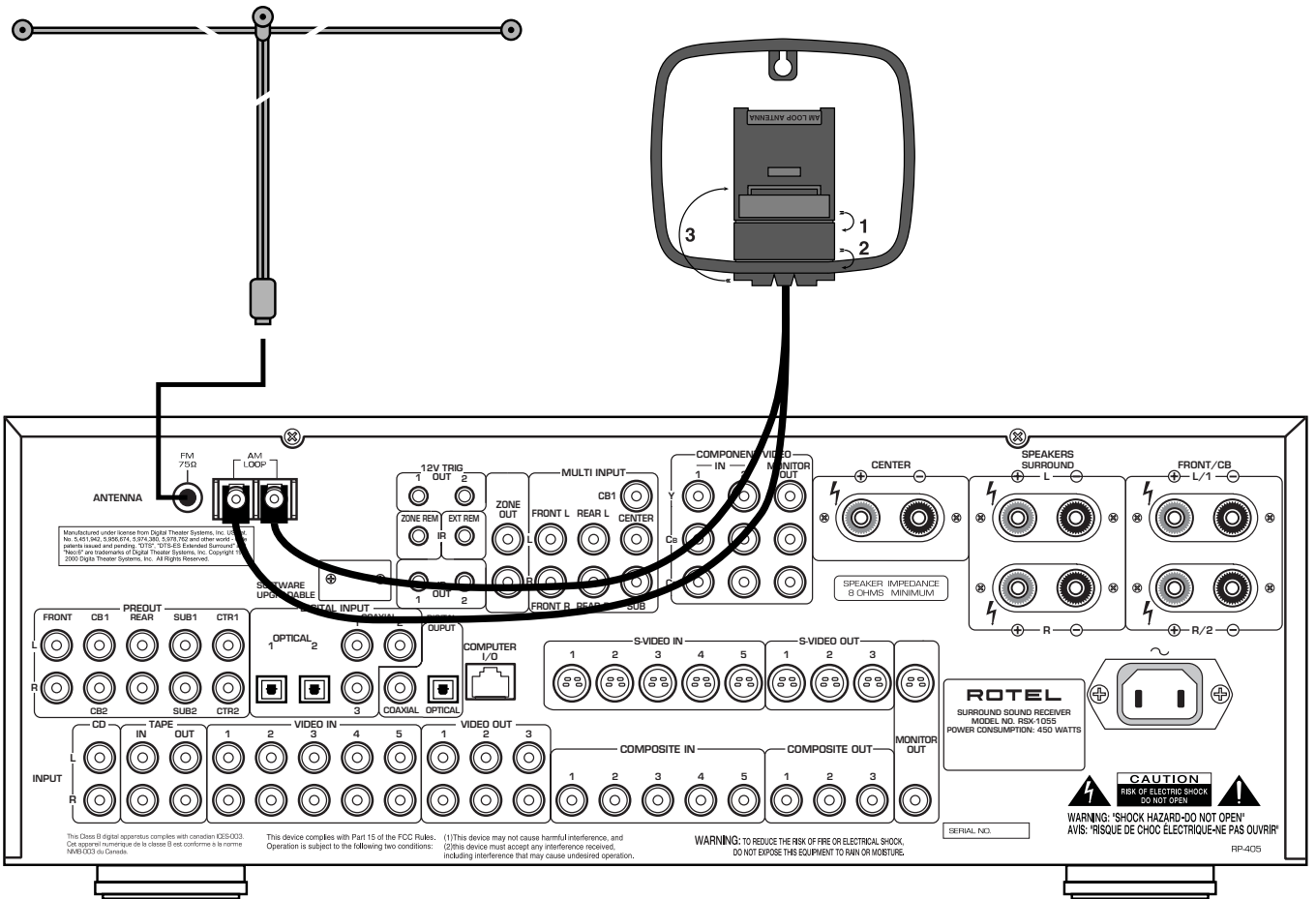

### 7: On-Screen Display Menus

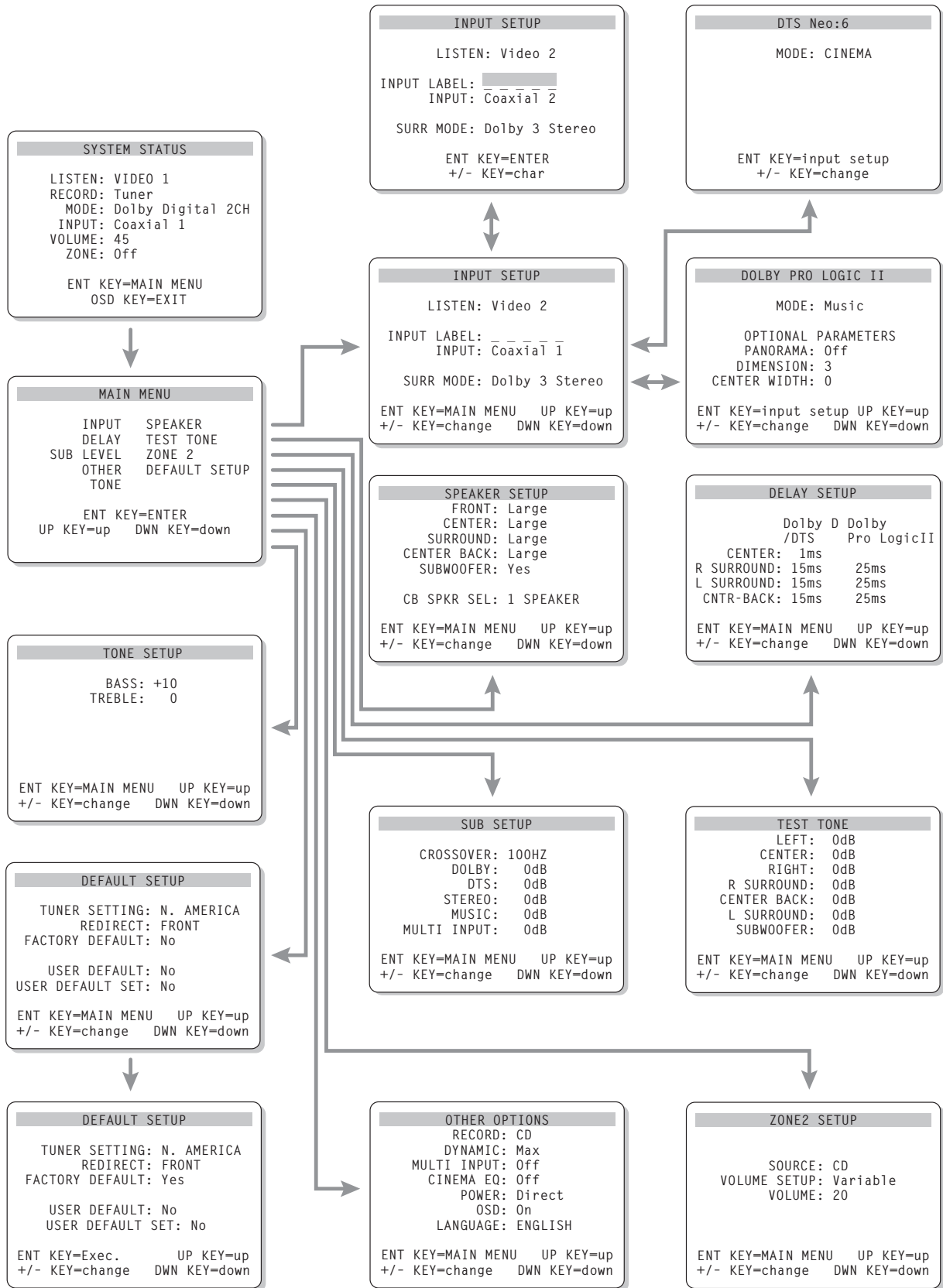

# Contents

Boxed numbers refer to RSX-1055 illustration.  
Boxed letters refer to RR-969 illustration.

<b>About Rotel</b> .....	12	<b>Digital Source Connections</b> .....	23
<b>Getting Started</b> .....	12	Digital Inputs <b>23</b> .....	23
Key Features .....	12	Digital Outputs <b>32</b> .....	23
Unpacking .....	13	<b>Output Signal Connections</b> .....	24
Placement .....	13	TV Monitor Output <b>30 42</b> .....	24
<b>RR-969 Remote Control</b> .....	13	Speaker Outputs <b>31</b> .....	24
Using the RR-969 <b>A</b> .....	13	Preamp Outputs <b>20</b> .....	24
Programming the RR-969		<b>Antenna Connections</b> .....	24
PRELOAD Button <b>Z</b> .....	13	AM Antenna <b>22</b> .....	25
<b>Basic Controls</b> .....	13	FM Antenna <b>21</b> .....	25
POWER Button <b>1 L</b> .....	13	<b>Power and Miscellaneous Connections</b> ...	25
Remote Sensor <b>2</b> .....	13	AC Input <b>43</b> .....	25
Front-panel Display <b>5</b> .....	13	12V TRIGGER Connections <b>26</b> .....	25
Volume Control <b>11 N</b> .....	14	EXTERNAL REM IN <b>27</b> .....	25
MUTE Button <b>P</b> .....	14	Computer I/O <b>33</b> .....	25
Tone Adjustments <b>I D</b> .....	14	<b>Zone 2 Connection and Operation</b> .....	25
FILTER Button <b>G</b> .....	14	Zone 2 Power On/Off Operation .....	26
MENU Button <b>Q</b> .....	14	Controlling Zone 2 from the Main Room	
ENTER Button <b>R</b> .....	14	ZONE Button <b>18</b> .....	26
<b>Input Controls</b> .....	14	Controlling Zone 2 from the Remote Location ...	26
Input Source Buttons <b>6 F</b> .....	14	Zone 2 Audio Outputs <b>28</b> .....	26
REC Button <b>19</b> .....	14	ZONE REM IN Jack <b>25</b> .....	27
ZONE Button <b>U</b> .....	15	IR OUT Jacks <b>24</b> .....	27
MULTI Input <b>16</b> .....	15	<b>On-Screen Display and</b>	
EXT IN <b>H</b> .....	15	<b>System Configuration</b> .....	27
<b>Overview of Surround Formats</b> .....	15	Navigation Buttons <b>D Q R S</b> .....	27
Dolby Surround .....	15	SYSTEM STATUS Menu .....	28
Dolby Pro Logic .....	15	MAIN Menu .....	28
Dolby Digital .....	15	INPUT Menu .....	28
DTS 5.1 .....	16	DTS Neo:6 Sub-Menu .....	29
6.1 and 7.1 Surround .....	16	DOLBY PRO LOGIC II Sub-Menu .....	29
Other Formats .....	16	SPEAKER SETUP Menu .....	29
DSP (Digital Signal Processing) .....	16	TEST TONE Menu .....	31
<b>Surround Controls</b> .....	17	DELAY SETUP Menu .....	31
Automatic Surround Modes .....	17	SUBWOOFER SETUP Menu .....	32
Manually Selecting Surround Modes .....	17	TONE SETUP Menu .....	32
2CH Button <b>12</b> .....	17	OTHER OPTIONS Menu .....	33
DOLBY PLII/3ST Button <b>13</b> .....	17	DEFAULT SETUP Menu .....	33
DTS Neo:6 Button <b>14</b> .....	18	ZONE 2 SETUP Menu .....	34
DSP Button <b>15</b> .....	18	<b>Specifications</b> .....	35
Setting Surround Modes from the Remote		Audio .....	35
SUR+ Button <b>W</b> .....	18	Video .....	35
Speaker Level Adjustment		FM Tuner .....	35
Selection Buttons <b>C E T</b> .....	18	AM Tuner .....	35
UP/DOWN Buttons <b>D</b> .....	18	General .....	35
DYNAMIC RANGE Button <b>17</b> .....	19		
DWN Button <b>D</b> .....	19		
<b>Tuner Controls</b> .....	19		
BAND Button <b>4 O</b> .....	19		
TUNING Buttons <b>3 M</b> .....	19		
MEMORY Button <b>10</b> .....	19		
NUMERIC Buttons: Station Presets <b>7 B</b> .....	19		
DIRECT Button <b>8 B</b> .....	20		
MONO Button <b>9</b> .....	20		
PRESET Button <b>V</b> .....	20		
<b>RDS and RBDS Broadcast Reception</b> .....	20		
DISPLAY Button <b>X</b> .....	20		
PTY Button <b>J</b> .....	21		
TP Button <b>Y</b> .....	21		
TA Button <b>K</b> .....	21		
<b>Connections: Overview</b> .....	21		
Video Connections .....	21		
<b>Audio Source Connections</b> .....	22		
CD Inputs <b>36</b> .....	22		
TAPE Inputs and Outputs <b>37</b> .....	22		
<b>Video Source Inputs</b> .....	22		
VIDEO 1–5 Audio Inputs <b>38</b> .....	22		
VIDEO 1–5 Composite Video Inputs <b>40</b> .....	22		
VIDEO 1–5 S-Video Inputs <b>34</b> .....	22		
VIDEO 1–2 Component Video Inputs <b>30</b> .....	22		
MULTI Inputs <b>29</b> .....	23		
<b>Video Source Outputs</b> .....	23		
VIDEO 1–3 Audio Outputs <b>39</b> .....	23		
VIDEO 1–3 Composite Video Outputs <b>41</b> .....	23		
VIDEO 1–3 S-Video Outputs <b>35</b> .....	23		

## About Rotel

A family whose passionate interest in music led them to manufacture high fidelity components of uncompromising quality founded Rotel 40 years ago. Through the years that passion has remained undiminished and the family goal of providing exceptional value for audiophiles and music lovers regardless of their budget, is shared by all Rotel employees.

The engineers work as a close team, listening to, and fine tuning each new product until it reaches their exacting musical standards. They are free to choose components from around the world in order to make that product the best they can. You are likely to find capacitors from the United Kingdom and Germany, semi conductors from Japan or the United States, while toroidal power transformers are manufactured in Rotel's own factory.

Rotel's reputation for excellence has been earned through hundreds of good reviews and awards from the most respected reviewers in the industry, who listen to music every day. Their comments keep the company true to its goal - the pursuit of equipment that is musical, reliable and affordable.

All of us at Rotel, thank you for buying this product and hope it will bring you many years of enjoyment.

"DTS", "DTS-ES Extended Surround", "DTS ES® Matrix 6.1", and "DTS ES® Discrete 6.1", and "DTS Neo:6®" are trademarks of Digital Theater Systems, Inc.

Manufactured under license from Dolby Laboratories. "Dolby", "Pro Logic", and the double-D symbol are trademarks of Dolby Laboratories.

HDCD®, HDCD®, High Definition Compatible Digital® and Pacific Microsonics™ are either registered trademarks or trademarks of Pacific Microsonics, Inc. in the United States and/or other countries. HDCD system manufactured under license from Pacific Microsonics, Inc. This product is covered by one or more of the following: In the USA: 5,479,168, 5,638,074, 5,640,161, 5,808,574, 5,838,274, 5,854,600, 5,864,311, 5,872,531, and in Australia: 669114. Other patents pending.

## Getting Started

Thank you for purchasing the Rotel RSX-1055 Surround Sound Receiver. The RSX-1055 is four products in one:

1. A digital surround sound processor for decoding virtually all analog (VHS tapes, etc.) and digital (DVD discs, etc.) surround sound recordings.
2. A full-featured audio/video control center for analog and digital source components.
3. A high-quality AM/FM tuner with RDS capability.
4. A 5-channel power amplifier to drive two front speakers (or two center back speakers), a center channel speaker, and two rear surround speakers.

### Key Features

- Rotel's Balanced Design Concept combines advanced circuit board layout, comprehensive parts evaluation, and extensive listening tests for superior sound and long term reliability.
- Dolby® Pro Logic II® decoding (for 5.1, 6.1, and 7.1 channel systems) with improved separation and frequency response for Dolby Surround® matrix encoded recordings. Can be optimized for Music or Cinema sources plus an emulation mode for the original Dolby Pro Logic decoding.
- Automatic Dolby Digital® decoding Dolby Digital® 2.0, Dolby Digital® 5.1, and Dolby Digital Surround EX® recordings.
- Automatic decoding for DTS® 5.1 channel, DTS-ES® Matrix 6.1 channel, and DTS-ES® Discrete 6.1 channel digital recordings.
- DTS® Neo:6® Surround modes for deriving surround channels for 5.1, 6.1 or 7.1 channel systems from 2-channel stereo or matrix surround recordings. Can be optimized for Music or Cinema sources.

- Rotel XS (eXtended Surround) automatically ensures proper decoding and optimum performance from any multichannel digital signal on 6.1 and 7.1 channel systems. Always active in any system with center back speaker(s), Rotel XS even works with signals that would not otherwise activate the proper decoding (such as non-flagged DTS-ES and Dolby Surround EX discs) or for which there is no extended surround decoder (such as DTS 5.1, Dolby Digital 5.1, and even Dolby Pro Logic II decoded Dolby Digital 2.0 recordings).
- Automatic HDCD® decoding for signals from High Definition Compatible Digital® compact discs.
- Automatic decoding of digital signals from MP3 (MPEG-1 Audio Layer 3) players.
- Surround modes for playback of surround sound material on 2 channel and 3 channel systems for total compatibility.
- Digital and analog input and output connections for digital signals, composite video, S-Video, and Component Video.
- Five built-in amplifier channels, each delivering 75 watts (all channels driven). The two front amplifier channels can be redirected to power center back speakers when using a separate stereo amplifier on the front speakers.
- AM/FM tuner with 30 station presets, direct access tuning, and auto-tuning.
- RDS (Radio Data Systems) and RBDS (Radio Broadcast Data Service) capability.
- Zone 2 output with independent input selection and volume adjustments for multi-zone custom installations along with IR-repeater capability for operation from the remote zone.
- MULTI Input for outboard adaptor and future upgradeability
- User friendly ON-SCREEN DISPLAY with programmable labels for video components. Choice of English or German languages.
- Universal learning remote control to operate the RSX-1055 and nine other components.
- Upgradeable microprocessor software to accommodate future upgrades.

## Unpacking

Remove the unit carefully from its packing. Find the remote control and other accessories. Save the box as it will protect the RSX-1055 if you move or need to return it for maintenance.

## Placement

Place the RSX-1055 on a solid, level surface away from sunlight, heat, moisture, or vibration. Make sure that the shelf can support the weight of the unit.

Place the RSX-1055 close to the other components in your system and, if possible, on its own shelf. This will make initial hookup, and subsequent system changes easier.

The RSX-1055 can generate heat during normal operation. Do not block ventilation openings. Allow a minimum of 10 cm (4 inches) of unobstructed space around the unit. If installed in a cabinet, make sure that there is adequate ventilation.

Don't stack other components or objects on top of the RSX-1055. Don't let any liquid fall into the unit.

## RR-969 Remote Control

The RSX-1055 includes a full-function learning remote control that can operate the RSX-1055 plus nine other components.

A separate manual, included with the remote, gives detailed instructions on programming and using the RR-969 to replace all of the remote controls in your system. To avoid duplication, we provide only basic information about using the RR-969 to operate the RSX-1055 in this manual.

---

*Most of the RR-969 functions duplicate the front-panel controls. For that reason, we will cover the operating controls on the remote in the appropriate sections of this manual. Letters in gray boxes next to the name of a function refers to the labeled illustration of the remote at the front of this manual.*

---

### Using the RR-969 **A**

To operate the RSX-1055 with the remote, make sure that the AUDIO mode is active by pressing the AUD button **A** on the remote before you start. The AUDIO mode will stay active until another DEVICE button is pressed.

## Programming the RR-969 PRELOAD Button **Z**

The RR-969 is preprogrammed to operate the RSX-1055. Should the AUDIO command set on your RR-969 not operate the RSX-1055, the programming may have been changed. To restore the RSX-1055 programming, press the recessed PRELOAD button **Z** on the remote with the tip of a ballpoint pen.

---

**NOTE:** *Pushing the PRELOAD button will erase all custom programming and learned commands, restoring the RR-969 to its factory condition.*

---

## Basic Controls

We suggest you look over the RSX-1055's front and rear panels before you start connecting other components. The following explanations will help you get familiar with the unit's connections, features, and controls.

Most functions are duplicated on the front-panel and on the remote. A few are found only on one or the other. Throughout this manual, numbers in gray boxes refer to the RSX-1055 illustration at the front of this manual. Letters refer to the RR-969 remote illustration. When both appear, the function is found on both the RSX-1055 and the remote. When only one appears, that function is found only on the RSX-1055 or the remote.

### POWER Button **1** **L**

The front-panel POWER switch on the RSX-1055 is a master power control allowing you to turn the unit on and off.

The button must be pressed IN for the unit to operate. When it is in the OUT position, the unit is fully off and cannot be activated from the remote control.

The POWER button on the remote functions as a standby switch, activating or deactivating the unit. In standby mode, minimal power is still supplied to memory circuits to preserve settings. When the unit has AC power applied and the front-panel POWER button is pressed IN, the front-panel POWER LED lights, regardless of whether the unit is in standby mode or fully activated in the main room.

There are three available power mode options for the RSX-1055, selected during setup from an ON-SCREEN DISPLAY menu. These options can be selected to best suit your particular system configuration. The normal DIRECT mode fully activates the unit whenever AC power is supplied and the front-panel POWER button is pressed IN; however, the remote POWER switch can still be used to activate or deactivate the unit. With the STANDBY power option, the unit powers up in standby mode when AC is first applied and the front-panel POWER button is pressed IN. The unit must be manually activated with the remote control POWER button. With the ALWAYS-ON power option, the unit is fully operational whenever AC is applied and the front-panel POWER button is pressed IN. The remote POWER button is disabled.

---

*When using Zone 2, the standby operation is completely independent for the main room and Zone 2. The remote control POWER button will not affect Zone 2. Pressing the POWER button on a remote located in Zone 2 will only affect that zone and not the main room. When the unit is activated in ZONE 2, the ZONE indicator in the front-panel FL DISPLAY is lit.*

---

### Remote Sensor **2**

This sensor receives IR signals from the remote control. Do not block this sensor.

### Front-panel Display **5**

The fluorescent (FL) display in the upper portion of the RSX-1055 provides information about the status of the unit, tuner reception, and activation of special features. The main portion of the display typically shows the current input source (or radio station frequency) selected for listening at the left and the current input source selected for recording at the right.

Icons along the left side of the display show the currently selected digital input. Icons at the right of the display show individual surround channels and are used in configuring the system. Icons across the bottom of the display show the current surround mode and other special features. Icons at the top of display assist in tuning radio stations and operation of RDS/RBDS features.

The FL display can be turned off, if desired. See the MENU button section for instructions.

## Volume Control **I** **N**

The VOLUME control adjusts the level of all output channels. Rotate the front-panel control clockwise to increase the volume, counterclockwise to decrease. The RR-969 remote has VOLUME UP and DOWN buttons.

When you adjust the volume, a digital readout appears in the front-panel display and the new setting appears on your TV monitor.

---

**NOTE:** The VOLUME control can be used to change the volume in Zone 2. Press the front-panel ZONE button and adjust the volume. After 10 seconds, the VOLUME control reverts to normal operation.

---

## MUTE Button **P**

Push the MUTE button once to turn the sound off. An indication appears in the front-panel and on-screen displays. Press the button again to restore previous volume levels.

## Tone Adjustments **I** **D** (remote only)

BASS and TREBLE adjustments (available only the remote control) increase or decrease the audio signal's low and high frequency content respectively. The front-panel display and ON-SCREEN DISPLAY show tone control settings as you adjust them.

To adjust the tone settings:

1. Press the SHIFT button **I** on the remote control. Either BASS or TREBLE appears in the front-panel display, depending on which adjustment is currently active. Press the SHIFT button again to toggle to the other adjustment.
2. Press the UP/DOWN buttons **D** on the remote to increase or decrease the setting. The display will revert to normal operation following several seconds of inactivity.

Tone adjustments can also be made from a menu screen in the ON-SCREEN DISPLAY system. See the Tone Setup section near the end of this manual.

---

**NOTE:** The tone adjustments are available for all surround modes and inputs, including the MULTI input.

---

## FILTER Button **G**

The FILTER button (remote only) activates or deactivates a special CINEMA EQ setting. This equalization may be desirable for playback of movie source material to compensate for the acoustic differences between a commercial cinema and a home theater environment.

The FILTER setting is independent for each source input. Using the button only changes the setting for the currently active source input.

## MENU Button **Q**

Push this button on the remote to turn on the ON-SCREEN DISPLAY menu system. If the menu system is already visible, push this button to cancel the display.

The front panel FL display can be turned off by pressing and holding the MENU button on the remote for three seconds. Briefly press the MENU button again to turn the display back on. The display also turns back on whenever the POWER button on the front-panel or remote is pressed.

## ENTER Button **R**

The ENTER button is used to confirm and memorize various settings in the setup and operation of the RSX-1055. Its use is described in detail in the relevant sections.

# Input Controls

## Input Source Buttons **6** **F**

Press any of the eight front-panel buttons to select an audio or video input source (the built-in tuner, CD, VCR, etc.) for listening. You will hear this source and, if you have selected a video source, see its picture on your TV monitor.

The front-panel display and the ON-SCREEN DISPLAY show the name of the current listening source selection. The labels for VIDEO sources can be customized to match your components.

---

**NOTE:** When the TUNER input source button is pressed, the frequency of the currently tuned station is displayed. Pressing the button again toggles the display to show the word TUNER instead of the frequency display.

---

All of the source inputs can be customized using the ON-SCREEN DISPLAY configuration menus to accept either analog signals or digital signals from one of the five assignable digital inputs. When a digital input is assigned, the RSX-1055 checks for the presence of a digital signal at that input. If a digital signal is present when the source is selected, it is automatically activated and the proper surround mode enabled. If no digital signal is present, the analog inputs for that source are selected. This auto-sensing is the preferred configuration for digital source inputs such as DVD players. When an ANALOG input is assigned, the unit will not access a digital signal, even though one may be available at the digital input.

By default, the source input buttons are factory configured to select the following inputs:

CD:	Analog input
Tuner:	Analog (built-in)
Tape:	Analog input
Video 1:	Digital Coaxial 1
Video 2:	Digital Coaxial 2
Video 3:	Digital Coaxial 3
Video 4:	Digital Optical 1
Video 5:	Digital Optical 2

Each source input should be configured using the ON-SCREEN DISPLAY menu system to use the desired input type (analog or digital auto-sensing). See the INPUT MENU section for configuration instructions.

---

**NOTE:** In addition to selecting analog or digital signals, the configuration options also permit custom labeling and selection of a default surround mode for each of the seven inputs plus the built-in tuner.

---

The input source buttons can also be used (with the REC button **19** described in the next section) to select an analog input source signal to be available at the outputs for recording. Additionally, the input source buttons can be used with the ZONE button **18** to select an analog input source for ZONE 2.

## REC Button ZONE Button

The RSX-1055 can record from any analog source to a VCR or other recorder connected to the VIDEO 1, 2 or 3 outputs or the TAPE outputs, even while you are listening to a different input source. To select an input source for recording, press the REC button on the front-panel (or the equivalent ZONE button on the remote). Then, press one of the INPUT SOURCE buttons within 5 seconds to select the signal you wish to record. After making your selection (or if more than five seconds passes), the input source buttons return to their normal function, selecting a listening source.

Remember, this selection is independent of the listening source. While recording, you may still select a different source (for example, the built-in tuner) for listening. The record selection appears in the display to the right of the listening selection.

**NOTE:** *The RECORD function requires analog signals. If you use a digital connection from a CD player or DVD for listening, you should also connect an analog signal for recording.*

## MULTI Input EXT IN

The MULTI INPUT button (or the EXT IN button on the remote) overrides all other audio inputs (both analog and digital) and selects the audio signal from an external digital adaptor. This input only changes the audio signal; the video signal from the currently selected input remains in use. When activated, the RSX-1055's digital processing is bypassed. An indicator appears in the front-panel display.

Since the RSX-1055 has built-in decoding for virtually all analog and digital surround formats, these inputs will not be necessary in most systems. Typically, you will connect a single digital cable or left/right analog RCA cables from each source to the INPUT SOURCE connections and allow the RSX-1055 to decode the surround information. However, the MULTI INPUT provides the capability to handle any future surround encoding format.

**NOTE:** *When the MULTI input is selected, the CB output is available only at the CB1 PREOUT connector. No signal is available at the CB2 PREOUT connector when the MULTI CH input is selected.*

## Overview of Surround Formats

To get the best performance from your RSX-1055, it helps to understand the many surround sound formats available today, to know which decoding process to use for a particular recording, and how to select it. This section provides basic background information about surround sound formats. The next sections provide detailed operating instructions.

### Dolby Surround Dolby Pro Logic

The most widely available surround sound format for consumer audio/video is Dolby Surround®, available on nearly all commercial VHS tapes, many television broadcasts, and most DVDs. Dolby Surround is the consumer version of the analog Dolby Stereo system first introduced in the film industry in 1972. It is a matrix-encoding system that records front left, front center, front right, and a mono surround channel into a 2-channel stereo recording. During playback, a Dolby Pro Logic® decoder extracts each channel and distributes it to the appropriate speakers.

Dolby Pro Logic decoding delivers a mono signal with reduced high-frequency content to the surround speakers. The more advanced decoder in the RSX-1055, Dolby Pro Logic II, increases the separation and frequency response of the surround channels for significantly improved performance with Dolby Surround encoded recordings.

Dolby Pro Logic II decoding is used for any analog soundtrack or recording labeled "Dolby Surround" or any Dolby Digital 2.0 soundtrack. While it is specifically designed to decode Dolby Surround recordings, Dolby Pro Logic can derive surround sound from conventional 2-channel stereo recordings, using phase relationships to extract front, right, center, and surround channels.

Activate Dolby Pro Logic II decoding with the Dolby PLII/3ST button described in the next section of the manual.

### Dolby Digital

In 1992, an entirely new digital recording system, called Dolby Digital, was first used in the film industry. Dolby Digital is a recording/playback system that uses compression techniques to store large amounts of audio data efficiently, much like the JPEG format stores large photographs in small files on a computer. Dolby Digital is the standard audio format for DVDs and for digital television broadcasting in the United States.

The Dolby Digital system can be used to record up to six discrete audio channels, but can also be used for fewer. For example, a Dolby Digital 2.0 recording is a 2-channel stereo recording such as a matrix encoded Dolby Surround soundtrack. To play this type of recording, use Dolby Pro Logic II decoding as previously described.

The most common use of Dolby Digital, in both the film industry and in home theater, is Dolby Digital 5.1. Instead of encoding multiple surround channels on a two-channel recording, Dolby Digital 5.1 records six discrete channels: front left, front center, front right, surround left, surround right, and a Low Frequency Effects (LFE) channel containing ultra-low bass signals intended for a subwoofer. A Dolby Digital decoder extracts the channels from the digital bitstream, converts them to analog signals and routes them to the appropriate speakers. All channels provide full frequency response with total separation between all channels and large dynamic range capability. A Dolby Digital 5.1 soundtrack will provide significantly more impressive surround sound than Dolby Pro Logic decoding of matrix Dolby Surround.

Decoding of Dolby Digital 5.1 soundtracks is automatic. When the RSX-1055 detects a Dolby 5.1 signal on one of its digital inputs, it activates the proper processing. Keep in mind that Dolby Digital is only available from digital sources (a DVD, a LaserDisc, or a Digital TV/Cable/SAT tuner). Also, you must connect the source with a digital cable (coax or optical) to an active digital input on the RSX-1055.

**NOTE:** *Many DVDs have a Dolby Digital 2.0 matrix soundtrack as the default, which should be decoded with Pro Logic II. The Dolby Digital 5.1 soundtrack may have to be selected as an option from the setup menus at the beginning of the DVD. Look for a Dolby Digital 5.1 selection under "Audio" or "Languages" or "Setup Options" when you insert the disc.*

## DTS 5.1

DTS® (Digital Theater Systems) is an alternative digital format competing with Dolby Digital in both movie theaters and home theater markets. The basic features and functions of the DTS system are similar to those of Dolby Digital (for example, 5.1 discrete channels), however the technical details of the compression and decoding processes differ somewhat and a DTS decoder is required.

Like Dolby Digital, DTS can only be used on a digital recording and, therefore, is only available for home use on LaserDiscs, DVDs, or other digital formats. To use the RSX-1055's DTS decoder, you must connect your DVD player to the RSX-1055's digital inputs.

As with Dolby Digital 5.1, detection and proper decoding of DTS 5.1 signals is automatic.

**NOTE:** DVDs with a DTS soundtrack almost always have it configured as an option to the standard matrix Dolby Surround format. To use DTS, you may have to go to the setup menus at the beginning of the DVD and select "DTS 5.1" instead of "Dolby Surround" or "Dolby Digital 5.1". In addition, many DVD players have the DTS digital bitstream turned off by default and cannot output a DTS soundtrack, even if selected on the disc's menu, until you activate the player's DTS output. If you hear no sound the first time you attempt to play a DTS disc, you may have to go to the DVD player's configuration menus and turn on the DTS bitstream. This is a one-time setting and need only be done once. See your DVD owners manual for details.

The RSX-1055 features a second type of DTS surround sound decoding: DTS Neo:6. This decoding system is similar to Dolby Pro Logic II in that it is designed for playback of any 2-channel stereo recording, either matrix-encoded or not. The Neo:6 decoder can be used with any conventional 2-channel source such as a stereo TV or FM broadcast or a CD. It can also be used as an alternative method of decoding matrix-encoded Dolby Surround recordings or TV broadcasts. Activate the DTS Neo:6 decoding with the DTS:Neo 6 button as detailed later in this section. DTS Neo:6 is not used with DTS 5.1 digital sources and the button need not be pressed for those recordings.

## 6.1 and 7.1 Surround

In 1999, the first Dolby Digital soundtrack was released to theaters with an additional center back surround channel, intended to increase the directional effects from behind the audience. This additional surround channel is encoded into the two existing surround channels in Dolby Digital 5.1, using a matrix encoding process similar to that used previously in Dolby Surround. This new extended surround capability is called Dolby Digital Surround EX.

DTS has added a similar capability for recording this extended surround information called DTS-ES® 6.1 Matrix. They have also taken it one step further and developed the capability to record this extended surround information as a fully discrete channel in a system called DTS-ES® 6.1 Discrete.

All of these systems are extensions of the existing Dolby Digital 5.1 and DTS 5.1 digital surround sound formats. Users with one center back speaker (a 6.1 configuration) or two center back speakers (a 7.1 configuration) can take advantage of this extended surround information. Users with traditional 5.1 channel systems can play Dolby Digital Surround EX or DTS-ES 6.1 discs and they will sound exactly the same as 5.1 channel discs in each respective format. The extended surround recordings are 100% backwards compatible.

If you have configured your system with one or two center back speakers, decoding of DTS-ES discs is automatic, just as it is with standard DTS soundtracks. Likewise, decoding of Dolby Digital Surround EX discs is automatic with one exception. Some early Surround EX titles did not have the detection "flag" encoded on the disc. To activate the Dolby Digital Surround EX features for these discs or for standard 5.1 channel Dolby Digital discs, use the Dolby PLII/3ST button described in the next section of this manual.

The RSX-1055 also features Rotel XS (eXtended Surround) processing that automatically ensures optimum extended surround performance on 6.1 and 7.1 channel systems. The key benefit of Rotel XS is that it works at **all** times with **all** multichannel digital signals, even those that might not otherwise activate proper surround decoding for the center back channel(s). Always active in any system configured with center back speaker(s), Rotel XS monitors the surround channels, properly decodes them, and distributes the extended surround channels to the center back speaker(s). Rotel XS works with

matrix-encoded surround signals (such as non-flagged DTS-ES and Dolby Surround EX discs) as well as non-matrix digital source material (such as DTS 5.1, Dolby Digital 5.1, and even Dolby Pro Logic II decoded Dolby Digital 2.0 recordings) to derive superb center back channel surround effects.

## Other Formats

Three other digital formats are not surround sound formats at all, but rather systems for digital 2-channel recordings.

The first is PCM 2-channel. This is a straight 2-channel digital signal such as that used for standard CD recordings.

The second is HDCD® encoding for compact discs. This system uses a variety of enhancements to improve the sonic performance compared to standard audio CDs. These discs, labeled HDCD, can be played on standard CD players. However, when the digital signal is decoded using an HDCD decoder like that in the RSX-1055, they will provide exceptional musical reproduction.

The RSX-1055 also features a decoder for the digital MP3 (MPEG1-Audio Layer 3) compression format. MP3 format recordings are available on the Internet and can be played on portable MP3 players or some disc players that can read CD-ROM discs.

PCM 2-channel, HDCD, and MP3 are digital formats. They can only be decoded by the RSX-1055 from digital sources connected to the digital inputs.

## DSP (Digital Signal Processing)

Finally, one more related issue to be addressed is DSP modes. Unlike all of the formats mentioned above, DSP is not a recording/playback system. Instead, it is a digital processing feature of the RSX-1055 that adds special acoustic effects to any signal. DSP processing can be used with Dolby Surround recordings, Dolby Digital recordings, CDs, radio broadcasts, or any other source material; however, typically DSP settings would be used with source material for which there is no specific surround decoder.

In general, DSP is used to create the ambience of a large listening environment: a jazz club, a concert hall, a stadium, etc. It uses digital processing to delay the signal to various speakers and mix in various levels of reverberation. Its use is strictly a matter of personal taste.



# Surround Controls

## Automatic Surround Modes

Decoding of digital sources connected to the digital inputs is generally automatic, with detection triggered by a “flag” embedded in the digital recording telling the RSX-1055 what decoding format is required. For example, when Dolby Digital 5.1 or DTS 5.1 channel surround is detected, the RSX-1055 activates the proper decoding, confirmed by a lighted indicator in the front-panel display.

The unit will also detect DTS-ES Matrix 6.1 or DTS-ES Discrete 6.1 discs and activate DTS-ES® Extended Surround decoding. Dolby Digital Surround EX recordings also trigger automatic decoding (although not all of the early Surround EX DVDs had the necessary flag and may require manually activating Surround EX decoding). Likewise, a digital input from an HDCD® encoded compact disc, a standard CD, or MP3 player will be auto-detected and properly decoded to 2CH stereo operation.

Rotel XS processing is automatically active in all systems configured with center back speaker(s) and will ensure proper extended surround decoding of all multichannel digital signals, even those that might not otherwise trigger the proper extended surround mode.

In many cases, the RSX-1055 will also recognize a digital signal with Dolby Surround encoding (such as the default soundtrack on many DVDs) and activate Dolby® Pro Logic II® decoding. Additionally, you can configure a default surround mode for each input using the ON-SCREEN DISPLAY menu system.

**NOTE:** A digital signal coming into the RSX-1055 will be recognized and properly decoded. However, on a DVD with multiple soundtracks, you must tell the DVD player which one to send to the RSX-1055. For example, you may need to use the DVD's menu system to select the Dolby Digital 5.1 or DTS 5.1 soundtrack rather than the default Dolby Digital 2.0 Dolby Surround soundtrack. If in doubt about what type of soundtrack is being sent from the DVD, check the front panel indicator lights on the RSX-1055 to see which type of decoding is activated: Dolby Pro Logic (for Dolby Surround matrix soundtracks), Dolby Digital, or DTS.

## Manually Selecting Surround Modes

Four front panel MODE buttons and the SUR+ button on the remote provide manual selection of surround sound settings when you wish to use a surround mode that is not automatically detected or, in some cases, when you wish to override an automatic setting.

Manual settings available from the front panel and/or the remote might be used when you want to play:

- standard 2-channel stereo (left/right speakers only) – press the 2CH button
- Dolby 3-channel stereo (left/right/center) or Pro Logic II processing of any source material, including material that is not Dolby Surround encoded – press the Dolby PLII/3ST button to toggle to the desired mode.
- 6.1, or 7.1-channel Dolby Digital Surround EX surround sound from Dolby Digital 5.1 channel digital sources or from Dolby Digital Surround EX discs that do not trigger automatic decoding – press the Dolby PLII/3ST button to toggle to the desired setting while a digital disc is playing.
- Derived 5.1, 6.1, or 7.1-channel surround for music or cinema from 2-channel sources using DTS Neo:6 processing – press the DTS Neo:6 button.
- 5-channel or 7-channel stereo from 2-channel sources – press the DSP button to toggle to the 5CH Stereo or 7CH Stereo setting.
- Four DSP ambience settings simulating concert halls - press the DSP button to toggle to the desired MUSIC effect.

The manual surround sound options are only available for certain source material and surround modes. Some discs may automatically activate one of the following surround modes with override options as follows:

- DTS, DTS-ES Matrix 6.1, DTS-ES Discrete 6.1, Dolby Digital, MP3, HDCD (96kHz), and PCM 2-channel (96kHz) digital signals are auto-detected and cannot be overridden. However, you can choose to use Dolby Digital Surround EX decoding for any Dolby Digital 5.1 source material.
- HDCD (non 96kHz) and PCM 2-channel (non 96kHz) digital signals can be overridden to Dolby Pro Logic II, Dolby 3-Stereo, DTS Neo:6, Music 1 – 4, 5CH Stereo, 7CH Stereo, and Stereo.

- Dolby Digital 2-channel Stereo can be overridden to Dolby Pro Logic II, Dolby 3-Stereo, and Stereo.

The following topics describe the use of each of the surround mode buttons in greater detail.

### 2CH Button **I2**

Press this button to activate conventional 2-speaker stereo mode with no surround sound or other processing. This is “pure” stereo, using the front left and front right speakers (with or without subwoofer), with no surround channels and no center channel.

When used with Dolby Digital or DTS source material, the 2CH button engages a downmix feature, combining all of the channels and sending them to the front speakers. The spatial effects of surround sound are lost, but all of the information on the original recording are preserved.

**NOTE:** 2CH mode allows you to hear 2-channel stereo recordings in their original format using the analog inputs.

### DOLBY PLII/3ST Button **I3**

This button offers two settings for Dolby processing: Dolby Pro Logic II and Dolby 3-Stereo. Press the button once to activate Dolby Pro Logic II (with the last used settings). Press again to toggle to the Dolby 3-Stereo setting. A front-panel display indicator shows the selected mode.

Use Dolby 3-Stereo for playback on front and center speakers, but no rear surround. With stereo recordings, it derives a center channel signal. With 5.1 channel recordings, the surround channels are mixed into the front speakers for a larger, more ambient sound than conventional stereo.

Dolby Pro Logic II decodes surround sound from any matrix encoded Dolby Surround 2-channel recording. It also can be used to create ambience in 2-channel musical source material that is not Dolby Surround encoded.

There are three optional modes for Dolby Pro Logic II decoding:

**MUSIC:** optimized for music.

**CINEMA:** optimized for movie soundtracks.

**EMULATION:** emulates the older Dolby Pro Logic decoder with mono frequency-limited surround channels.

When the PRO LOGIC II setting is selected, the front-panel display shows that Pro Logic II decoding is activated, along with the current mode setting (MUSIC, CINEMA, EMULATION).

The mode setting can be changed using the ON-SCREEN MENU system. You can also switch among the three mode settings (MUSIC, CINEMA, EMULATION) by pressing the +/- buttons **S** on the remote control. However, this feature works **only** when the Pro Logic II surround mode is active and when the ON-SCREEN MENU system is not being displayed.

### Dolby Digital Surround EX

If you have one or more center back speakers, Dolby Digital Surround EX decodes the center back channel encoded on Dolby Digital Surround EX recordings as well as deriving a center back channel signal from Dolby Digital 5.1 channel recordings.

In many cases, a Dolby Digital Surround EX signal will be auto-detected and the proper decoding will be automatically activated (assuming you have configured your system to have one or more center back speakers.)

If a Dolby Digital Surround EX disc does not have the auto-detection flag or if you wish to use Surround EX decoding to derive a center back channel from a Dolby Digital 5.1 channel source, you can make the selection manually by pressing the DOLBY PLII/3ST button or the +/- buttons **S** on the remote control, but **only when a Dolby Digital recording is currently being played and decoded.** Once this setting is made, it is memorized for future Dolby Digital listening sessions.

**NOTE:** You may prefer to leave Dolby Digital processing in the standard 5.1 channel mode and allow the Rotel XS processing automatically optimize the surround output for 6.1 and 7.1 systems. Rotel XS works with all multi-channel digital signals, including non-flagged Dolby Digital Surround EX discs as well as sources that would not otherwise activate an extended surround decoder.

### DTS Neo:6 Button **I4**

The DTS Neo:6® mode provides advanced matrix processing to generate 5.1 and 6.1 surround channels from two-channel source material, much like Dolby Pro Logic II. DTS Neo:6 can process analog 2 channel sources, digital 2-channel sources, and matrix encoded digital 2-channel sources.

DTS Neo:6 features two different decoding settings, one optimized for music sources and the other optimized for cinema sources. Press the DTS Neo:6 button to activate Neo:6 processing in the last previously used mode. The DTS icon lights and the label Neo:6 scrolls in the FL display followed by "CINEMA" or "MUSIC" depending on the currently active mode.

Press the Neo:6 button again to toggle to the Neo:6 CINEMA mode. You can also change the Neo:6 mode using the ON-SCREEN MENU system. Or, you can press the +/- buttons **S** on the remote after Neo:6 is activated to change between cinema to music modes: however, this feature only works when Neo:6 processing is active and the ON-SCREEN MENU system is not being displayed.

**NOTE:** It is not necessary to press this button when playing a DTS or DTS-ES encoded digital disc. Activation of the correct decoding for these discs is automatic, as indicated by the illumination of the DTS indicator in the front-panel display.

### DSP Button **I5**

This button activates digital synthesis of six ambience modes (MUSIC 1, MUSIC 2, MUSIC 3, MUSIC 4, 5CH Stereo, and 7CH Stereo).

- The four MUSIC settings use digital delay and reverberation effects to simulate progressively larger acoustic environments. Typically used to add ambience and a sense of space when listening to music sources or other sources that lack surround sound encoding.
- 5CH Stereo derives surround channels from stereo source material on a 5 channel system (FRONT LEFT/RIGHT, CENTER, and SURROUND LEFT/RIGHT).
- 7CH Stereo derives surround channels from stereo source material on a 7 channel system (FRONT LEFT/RIGHT, CENTER, SURROUND LEFT/RIGHT, and CENTER BACK 1/2).

Press the button to activate the DSP mode. Each press of the button will step forward to the next mode in the following order: MUSIC 1 > MUSIC 2 > MUSIC 3 > MUSIC 4 > 5CH Stereo > 7CH Stereo. An indicator lights in the front-panel display when DSP mode has been activated.

## Setting Surround Modes from the Remote SUR+ Button **W**

The SUR+ button on the remote selects the surround modes described in the previous section. Each time you press the button, the surround mode cycles to the next setting (2-Stereo > Dolby Pro Logic II > Dolby 3-Stereo > Music 1 – 4 > 5CH Stereo > 7CH Stereo > Neo:6 > 2-Stereo) as indicated by the front-panel display and an ON-SCREEN DISPLAY indicator. Repeatedly press the button until you reach the desired setting.

**NOTE:** The following types of source material are generally detected automatically and the proper decoding activated with no action required: DTS, DTS-ES Matrix 6.1, DTS-ES Discrete 6.1, Dolby Digital, MP3, HDCD and PCM 2-channel. Some surround modes may not be available for all source signals.

## Speaker Level Adjustment Selection Buttons **C E T** UP/DOWN Buttons **D**

The levels of all channels should be calibrated using test tones with an ON-SCREEN DISPLAY menu during the initial setup of the RSX-1055. You can also make a temporary change in the relative volume of the center, rear, or subwoofer channels using buttons on the remote control:

1. Press a selection button on the remote to select a channel (or pair of channels) for adjustment. Press the C button **C** to adjust the CENTER channel. Press the S button **E** to adjust the SUBWOOFER channel. Press the R button **T** to adjust the rear SURROUND or CENTER BACK channels (each press of the R button toggles between the SURROUND channels and the CENTER BACK channels). The selected speaker and its current setting appear briefly in the display.
2. Use the UP or DOWN buttons **D** on the remote to adjust the output level of the selected channel(s).
3. Repeat the procedure for each channel.

If no level adjustment is made for 5 seconds after pressing one of the selection buttons, the levels revert to the default calibrated settings.

**NOTE:** This adjustment is temporary. Selecting a different input or turning the unit off reverts to the default levels.

## DYNAMIC RANGE Button **17** DWN Button **D**

Digital sources are capable of wide dynamic range (the difference between the softest and loudest sounds). In some cases, this may tax amplifiers and/or speakers. In other cases, you may want to reduce the dynamic range when listening at low volume levels. Pressing the front-panel DYNAMIC RANGE button (or the DWN button on the remote) steps through the three dynamic range settings:

- **MAX** (no compression/full dynamic range)
- **MID** (moderate compression)
- **MIN** (full compression/minimum dynamic range)

A "D. RANGE" indicator in the front-panel display lights when the dynamic range is not set to the MAX setting. The new dynamic range setting appears briefly in the alphanumeric display when the setting is changed.

**NOTE:** The DYNAMIC RANGE feature is only available in Dolby Digital mode. It is designed to keep dialog intelligible while adjusting the loudest and softest sounds.

## Tuner Controls

The RSX-1055 features a digital synthesized AM/FM tuner with RDS capability and 30 station presets. The unit offers a wide range of tuning options. Here is an overview of the tuning options (more detailed information is provided in subsequent sections of this manual):

- **Manual frequency tuning** tunes up or down to the next station frequency (when in frequency tuning mode). Press and release a TUNING button (CH UP/DOWN on the remote) to tune.
- **Direct frequency tuning** lets you enter the desired station frequency digits. Press the DIRECT button (or the +10 button on the remote) and enter the digits using the NUMERIC buttons.
- **Automatic frequency search tuning** searches up or down to find the next receivable broadcast signal. Press and hold a TUNING button (CH UP/DOWN on the remote) for at least one second to search up or down.

- **Station preset tuning** lets you directly enter the number of a memorized station preset. Enter the number of the memorized preset using the NUMERIC buttons.
- **Preset search tuning** jumps up/down to the next memorized station preset. When in PRESET mode, press a TUNING button (CH UP/DOWN on the remote) to select the next station preset. Press the PRESET button on the remote to toggle between preset and frequency tuning modes.
- **RDS (Europe) or RBDS (USA) tuning** provides a range of special tuning and search features based on data codes encoded with the broadcast signal. See the RDS section of this manual for detailed information.

**NOTE:** The RSX-1055 comes configured for tuning in the market where you purchased it (N. America or Europe). To change this default setting, see the information on the DEFAULT SETUP on-screen menu later in this manual.

## BAND Button **4** **O**

Press the BAND button to toggle between AM and FM reception. An indicator in the front-panel display confirms your choice and the currently tuned station frequency is shown.

## TUNING Buttons **3** **M**

The TUNING buttons (labeled CH UP/DOWN on the remote control) provide three different tuning functions, depending on the mode of operation.

**In the normal FREQUENCY tuning mode,** press a TUNING button (CH UP/DOWN on the remote) and release to manually jump to the next station frequency, regardless of whether or not a station is broadcasting on that frequency. For auto frequency search tuning, press and hold the TUNING button for approximately one second. An AUTO indicator will appear in the front-panel display and the tuner will begin scanning up or down through the frequencies until the next available signal is detected. If this is not the desired station, repeat the automatic tuning procedure to find the next station. Weak stations will be skipped during auto tuning.

**In the PRESET tuning mode,** press a TUNING button (CH UP/DOWN on the remote) and release to jump to the next memorized station preset. Switch between FREQUENCY and PRESET tuning modes by pressing the PRESET button **V** on the remote control. A PRESET indicator appears in the display when PRESET TUNING is activated.

**In the RDS PTY search mode,** press a TUNING button (CH UP/DOWN on the remote) to select the desired program type from the scrolling list in the display. See the section on RDS tuning for more details.

**NOTE:** Several indicators in the front-panel display assist tuning. A large display shows the tuned frequency. A TUNED indicator lights when a sufficiently strong signal is received. A ST indicator lights when a stereo FM signal is received.

## MEMORY Button **10**

The MEMORY button is used with the NUMERIC buttons to store memorized station presets. See the next section for detailed instructions.

## NUMERIC Buttons: Station Presets **7** **B**

The RSX-1055 can store up to 30 station presets for recall at any time using the NUMERIC buttons on the front panel. To memorize a station:

1. Tune to the desired station, AM or FM.
2. Press the MEMORY button on the front-panel. A MEMORY indicator will flash for five seconds in the front-panel display.
3. While the MEMORY indicator is flashing, press the number of the preset where you wish to store the station frequency. For example, to memorize the station as preset 3, press the 3 button. To memorize preset 15, press the 1 button followed by the 5 button.
4. A previously stored frequency is erased from memory when a new frequency is memorized for the same preset number.

To tune to a previously memorized station, just press the preset number on the NUMERIC buttons. For example, to tune to preset 3, press the 3 button. To tune to preset 15, press the 1 button and then press the 5 button.

**NOTE:** If the TUNER is not already the selected input, pressing a NUMERIC button on the front-panel activates the TUNER. If using the NUMERIC buttons on the remote, first manually select the tuner input, if not already active.

The NUMERIC buttons can also be used for direct access tuning (see next section).

### DIRECT Button **8** **B**

If you know the frequency of the desired station, you may tune it directly using the DIRECT button and the NUMERIC buttons.

1. Press the DIRECT button **8** (or the +10 button on the remote) to change the NUMERIC buttons from station preset to Direct Access mode. The station frequency in the front-panel display will change to a series of four bars, representing the digits of a station frequency, with the first bar flashing.
2. Enter the first digit of the station frequency using the NUMERIC buttons **3**. The digit will appear in the frequency display and the second bar will flash. Enter the remaining digits of the frequency. When all of the necessary digits have been entered, the receiver will tune to the displayed station frequency. Note that entering a station frequency is slightly different for the USA and Europe:

In the USA:

FM87.50MHz Press: 8>7>5  
 FM101.90MHz Press: 1>1>9  
 AM1410kHz Press: 1>4>1

In Europe:

FM87.50MHz Press: 8>7>5>0  
 FM101.90MHz Press: 1>1>9>0  
 AM1413kHz Press: 1>4>1>3

### MONO Button **9**

The MONO button changes the FM mode from stereo reception to mono reception. In stereo mode, a stereo signal will be heard if the station is broadcasting a stereo signal and there is sufficient signal strength. An ST indicator light in the front-panel display. In mono mode, a mono signal will be heard even if the station is broadcasting a stereo signal.

**NOTE:** Switching to mono mode can improve the reception of weak or distant FM signals. Less signal strength is required for clean mono reception than for stereo reception.

### PRESET Button **V**

The PRESET button on the remote toggles between frequency tuning mode and preset tuning mode. In frequency tuning mode, the TUNING buttons (CH UP/DOWN on the remote) advance to the next station frequency. In preset tuning mode, the TUNING buttons advance to the next memorized station preset. A PRESET indicator in the front-panel display lights in preset mode.

## RDS and RBDS Broadcast Reception

The Rotel RSX-1055 is equipped with RDS (Radio Data Systems) reception capabilities for Europe and RBDS (Radio Broadcast Data Service) capabilities for the United States. These broadcast systems provide additional functionality to FM radio reception by transmitting encoded information along with the radio signal. This signal is decoded by an RDS or RBDS receiver and can provide a range of informational features including:

1. a display of the station's identifying name (e.g. BBC1)
2. a display of the station's program content (e.g. ROCK or NEWS)
3. traffic information broadcasts
4. a scrolling text display for announcements or information

In addition, RDS provides several advanced search features including:

1. Search for a station with the desired program content (PTY)
2. Search for traffic information (TP)
3. Search for stations broadcasting special traffic announcements (TA).

RDS broadcasting has been widely available in many European markets for years. There are a large number of RDS stations and most users will be familiar with the features and operation. In the USA, implementation of the RBDS system is more recent. Fewer stations are broadcasting RBDS signals and the features may be less familiar to many users. Consult your authorized Rotel dealer for more information on RDS or RBDS broadcasting in your area.

**NOTE:** The RDS and RBDS features are entirely dependent on the broadcaster sending encoded signals. Thus, they will only be available in markets where RDS or RBDS is implemented and where stations are broadcasting these data signals. If there are no RDS or RBDS stations, the RSX-1055 will function as a standard radio receiver.

**NOTE:** RDS and RBDS services are only available on FM broadcasts. The features and buttons described below are only operational in FM mode.

### DISPLAY Button **X**

There are five display options when the currently tuned station is broadcasting RDS information and the RDS indicator in the front-panel display is lit. Press the DISPLAY button on the remote to step through the five display options:

1. Standard FREQUENCY display.
2. PROGRAM SERVICE name. This is typically the station's call letters, such as BBC1. If the current station is not broadcasting an RDS signal, the display will show "NO NAME DATA".
3. PROGRAM TYPE. This is a description of the station's content from a standardized list of program types in each market. If the current station is not broadcasting an RDS signal, the display will show "NO PTY DATA".
4. CLOCK TIME. A time and date display broadcast by the station. If the current station is not broadcasting an RDS signal, the display will show "NO TIME DATA".
5. RADIO TEXT. Additional scrolling text messages broadcast by the station. If the current station is broadcasting radio text data, an RT indicator lights in the display and the scrolling text appears. If the current station is not broadcasting an RDS signal, the display will show "NO TEXT DATA".

## PTY Button **J**

The PTY search function permits you to scan available broadcasts for RDS stations broadcasting a particular type of program content.

1. Press the PTY button. The current RDS program type will appear in the display.
2. If desired, change to a different PROGRAM TYPE using the TUNING UP/DOWN buttons to scroll through the list.
3. Press the PTY button a second time within 5 seconds. The tuner will attempt to find an RDS station broadcasting the selected type of program. If the button is not pressed within 5 seconds after selecting a program type, the PTY function will be cancelled.
4. If no station is located for the desired content type, the tuner will return to the last previously tuned station.
5. Cancel the PTY function by pressing any other button.

---

**NOTE:** If the currently tuned station is broadcasting PTY data, a PTY indicator lights in the front-panel display.

---

## TP Button **Y**

Searches for an RDS station broadcasting traffic information programming:

1. Press the TP button. The tuner attempts to find an RDS station broadcasting the traffic programming. If a station is found, a TP indicator lights in the front-panel display.
2. If no station is located, the tuner will return to the last previously tuned station.
3. Cancel the TP function by pressing any other button.

## TA Button **K**

Searches for an RDS station broadcasting special traffic announcements:

1. Press the TA button. The tuner will attempt to find an RDS station broadcasting traffic announcements.
2. If no station is located, the tuner will return to the last previously tuned station.
3. Cancel the TA function by pressing any other button.

## Connections: Overview

The RSX-1055 connections include standard RCA audio inputs and outputs, composite video inputs and outputs, S-Video inputs and outputs, Component Video inputs, plus coaxial and optical digital inputs and outputs.

---

**NOTE:** Surround formats like Dolby Digital and DTS are digital formats and the RSX-1055 can only decode them when a digital input signal is available. For this reason, you should always connect your DVD player's digital outputs to the RSX-1055, using either the optical or coax inputs.

---

The RSX-1055 has RCA preamp audio outputs for use with external amplifiers as well as composite video, S-Video, and Component Video outputs to connect your TV monitor.

The RSX-1055 also has MULTI input connections, a remote IR sensor input, and two 12V trigger connections for remote turn-on of Rotel amplifiers.

---

**NOTE:** Do **not** plug any system component into an AC source until all connections have been properly made.

---

Video cables should have a 75 ohm impedance rating. The S/PDIF digital audio interface standard also specifies a 75 ohm impedance and all good digital cables adhere to this requirement. Because the video and S/PDIF standards are so close, you can use a video cable for digital audio data transmission. Do NOT substitute conventional audio interconnect cables for digital or video signals. Standard audio interconnects will pass these signals, but their limited bandwidth reduce performance.

When making signal connections, connect LEFT channels to LEFT channel jacks and RIGHT channels to RIGHT channel jacks. All RCA-type connections on the RSX-1055 follow these standard color codes:

**Left channel audio:** white RCA jack  
**Right channel audio:** red RCA jack  
**Composite video:** yellow RCA jack

---

**NOTE:** Each source input must be properly configured using the INPUT MENU of the ON-SCREEN DISPLAY system. We recommend going to this menu after connecting each source to configure it as desired. See the INPUT MENU section for information.

---

## Video Connections

The RSX-1055 provides S-Video and Component Video connections for those who wish to use them. However, standard Composite video cables provide excellent picture quality in most systems and their use for **all** input and output connections will greatly simplify installation and configuration of the unit.

If you choose to use S-Video or Component Video connections, be aware of the following implications for the configuration of your system:

**On Screen Menu Display:** The RSX-1055 ON-SCREEN MENU system is available for **all** inputs when using a Composite or S-Video cable from the TV MONITOR outputs to the TV set. The ON-SCREEN MENU is not available when using Component video cables.

**System Set-Up:** System setup should be done while using a Composite video or S-Video cable connecting the RSX-1055 TV MONITOR outputs to the video inputs of the TV or projector. Select OSD ( ON-SCREEN MENU) from the RR-969 remote control to complete system setup.

---

**NOTE:** On a PAL standard monitor, the OSD cannot be displayed until a video signal is present, irrespective of the type of video cables in use. For setup, connect the video output from your DVD player and select its input on the RSX-1055. The OSD will be displayed as an overlay to the video signal from the DVD player.

---

**Composite and S-Video:** With certain exceptions, a system should be connected with either **all** Composite or **all** S-Video cables. S-Video signals from sources cannot be sent to a TV set from the RSX-1055 TV MONITOR outputs with a Composite video cable. Conversely, Composite video signals from sources cannot be sent to a TV set from the RSX-1055 TV MONITOR outputs with an S-Video cable. Therefore, Composite and S-Video connections cannot be easily "mixed" in a system.

However, both Composite and S-Video cables may be connected from the RSX-1055 TV MONITOR outputs to both Composite and S-Video inputs on a TV or projector. This dual connection from the RSX-1055 will provide limited S-Video capability in a system that is predominantly connected with Composite video cables, however

it requires switching the input on the TV monitor when changing from an S-Video to an RCA Composite connected source.

When both Composite and S-Video cables are connected from the same source, **both** Composite and S-Video signals are available at the RSX-1055's TV MONITOR outputs, allowing the selection of the desired signal with the TV input selector. The Composite video signal is available at the REC Out for recording. This dual connection can be used to provide video taping in a system that is predominantly connected with S-Video cables, but also includes a VCR with Composite video.

**Component Video:** Component Video connections can significantly improve the picture quality when using a digital "high-definition" television monitor and a DVD player's progressive scanning feature. They provide little benefit with standard analog TV monitors. Their use will almost certainly require running multiple outputs to the TV and switching between the TV's various inputs when changing sources.

## Audio Source Connections

See Figure 4.

Connect your audio-only source components to these RCA inputs and outputs:

### CD Inputs **36**

Connect the left and right analog outputs from your CD player to the input jacks labeled CD.

### TAPE Inputs and Outputs **37**

The RSX-1055 provides a pair of inputs and a pair of record outputs for connecting an analog audio tape deck.

The analog source signal available for recording at the TAPE outputs is selected with the REC button on the front-panel (or the ZONE button on the remote) and its label appears in the display. If the TAPE input signal is selected as the recording source, its signal will not be available at the TAPE output, but will be available at the VIDEO outputs for recording.

Connect the left and right analog *outputs* from an audio tape deck to the TAPE IN jacks. Connect the TAPE OUT jacks to the *inputs* on the audio tape deck.

## Video Source Inputs

See Figure 4

There are input connections for five video source components. Each of the five provides a pair of RCA inputs for analog audio signals. Each of the five also provides a choice of an RCA composite video input or S-Video input for the video signal from the source component. In addition, two of the video source inputs (Video 1 and Video 2) also feature Component Video input connections as an alternative to the composite video or S-Video connections.

---

**NOTE:** *There is no need to use more than one type of video connection from a source component. We recommend selecting one type of video connection and using it for all video inputs and outputs. As a general rule, using RCA composite video connections will simplify system setup and operation. S-Video connections may provide improved picture quality. If all of your source components and your TV monitor have S-Video connections, then this would be a good choice for all video connections. If you mix RCA composite and S-Video connections, you will have to make both types of connections to your TV monitor and switch the monitor's input selector when changing source components.*

---

There are also video record outputs (described in a following section) which correspond to three of the video source inputs – Video 1, 2, and 3). For this reason, you should plan ahead and designate each source component as Video 1, Video 2, etc. All connections (both input and output) from a source component must be made consistently to the same set of connections. For example, **all** input and output connections to a particular VCR could be made to Video 1 connectors.

Also, be sure that the channels are connected consistently, i.e. left channel signals connected to left channel inputs/outputs and right channel signals connected to right channel inputs/outputs.

---

**NOTE:** *These video source inputs can also be used for additional audio-only sources, omitting the video signal connections.*

---

### VIDEO 1-5 Audio Inputs **38**

Using standard audio interconnect cables, connect the left and right channel analog audio *outputs* of VCRs or other source components to the VIDEO 1, 2, 3, 4, or 5 *inputs* using standard RCA audio cables.

### VIDEO 1-5 Composite Video Inputs **40**

If you use the RCA composite video connections for a source component, connect the RCA video *output* of the source component to one of the video *inputs* labeled COMPOSITE IN. Use a standard 75 ohm video cable.

### VIDEO 1-5 S-Video Inputs **34**

S-Video signals use a special cable which divides the video signal into several elements carried by separate conductors, providing higher quality than the standard RCA composite cables. If you choose to use an S-Video input connection from a source component, connect the S-Video *output* of that component to one of the *inputs* on the RSX-1055 labeled S-VIDEO IN using a standard S-Video interconnect cable.

---

**NOTE:** *Signals from S-Video inputs will only be available at the S-Video outputs to the TV.*

---

### VIDEO 1-2 Component Video Inputs **30**

Component Video connections split the video into three signals – luminance (Y) and separate chrominance (CB and CR) elements, allowing delivery of a reference-quality picture. Each of these signals is carried by a separate 75 ohm video cable with RCA connectors.

The VIDEO 1 and VIDEO 2 source inputs provide an option for using Component Video connections. If you choose to use Component Video input connection from a source component, connect the three Component Video *outputs* of that component to the corresponding *inputs* on the RSX-1055 labeled COMPONENT VIDEO IN. Make sure that you connect each of the three cables to the proper connector (Y to Y, CB to CB, and CR to CR) and that you use standard 75 ohm video interconnect cables.

---

**NOTE:** *Signals from Component Video inputs will only be available at the Component Video outputs to the TV monitor. The ON-SCREEN DISPLAY system is not available when using Component Video connections.*

---

## MULTI Inputs 29

These RCA inputs accept seven channels of analog signals from a 5.1 or 6.1 channel processor or source component. When selected with the front-panel MULTI INPUT button or remote EXT IN button, this input overrides any other audio input signal.

Use audio cables to connect the outputs of the source component to the RCA jacks labeled MULTI INPUT, making sure that you observe proper channel consistency, i.e. connect the right front channel to the R FRONT input, etc. Depending on your system configuration, you will make six connections (FRONT LEFT & RIGHT/SURROUND LEFT & RIGHT/CENTER/SUBWOOFER) or seven connections (FRONT LEFT & RIGHT/SURROUND LEFT & RIGHT/CENTER/CENTER BACK/SUBWOOFER).

## Video Source Outputs

See Figure 4.

Three of the available video sources (VIDEO 1, 2 and 3) feature outputs that allow you to send a signal to a VCR or other source component for recording. The recording signal available at all of these outputs is selected globally using the REC button on the front-panel or the ZONE button on the remote and is independent of the source selected for listening.

---

**NOTE:** Recording signals are available at all source outputs, including the source selected for recording. As a general rule, you should not attempt to record to the component whose signal has been selected for recording.

---

The record outputs for VIDEO 1, 2, and 3 include a pair of RCA analog audio outputs plus a choice of composite video or S-Video output. To hook up a video component for recording, you will need to connect it to both analog audio outputs and to your choice of video outputs. Keep in mind that composite video input signals will not be available at the S-Video record outputs and S-Video input signals will not be available at the composite video record outputs.

---

**NOTE:** All connections (both input and output) from a source component must be made consistently to the same set of connections. For example, if you designate a VCR as VIDEO 1, you must connect all of its input and output signals to the VIDEO 1 connectors.

---

## VIDEO 1–3 Audio Outputs 39

Using standard audio interconnect cables, connect the left and right channel RCA audio outputs from the RSX-1055 to the audio inputs on the source component. Make sure that you are consistent. If you hook up a VCR to the VIDEO 1 inputs, hook up the VIDEO 1 outputs to the same VCR. Also make sure that the left channel is connected to the LEFT connectors and the right channel to the RIGHT connectors.

## VIDEO 1–3 Composite Video Outputs 41

If you choose to use the RCA composite video connections for a source component, use a 75 ohm video interconnect cable to connect the RSX-1055's RCA video output (labeled COMPOSITE OUT) to the RCA video input on your VCR.

## VIDEO 1–3 S-Video Outputs 35

If you choose to use S-Video connections for a source component, use an S-Video cable to connect the RSX-1055's S-Video output (labeled S-VIDEO OUT) to the S-Video input on your source component.

## Digital Source Connections

See Figure 4.

The RSX-1055 provides digital connections which may be used in place of, or in addition to, the analog audio input and output connections described in the previous sections. These connections include five digital inputs and two digital outputs for recording.

These digital connections can be used with any source component that supplies a digital signal, such as a DVD player or CD player.

---

**NOTE:** A digital connection means that the digital processors in the RSX-1055 will be used to decode the signal, rather than the source component's internal decoders. In general, you must use digital connections for a DVD player or other component that supplies a Dolby Digital or DTS signal, otherwise the RSX-1055 will not be able to decode these formats.

---

## Digital Inputs 23

The RSX-1055 accepts digital input signals from source components such as CD players, satellite TV receivers, and 5.1 channel Dolby Digital, DTS, or 6.1 channel DTS-ES signals from DVD players. The built-in D/A converter senses and adjusts to the correct sampling rates.

There are five digital inputs on the rear panel, three coaxial and two optical. These digital inputs can be assigned to any of the input sources using the INPUT MENU screen described later in this manual. For example, you can assign the COAXIAL 1 digital input connector to the VIDEO 1 source and the OPTICAL 2 digital input to the VIDEO 3 source.

Connect the appropriate cable (optical or 75 ohm coaxial) from the digital output of your source component to a digital input on the RSX-1055 and then configure that digital input for use with the source component using the INPUT MENU.

---

**NOTE:** When using digital connections, you should also make the analog audio input connections described previously. The analog connection is necessary to record to an analog recorder or for ZONE 2 operation

---

## Digital Outputs 32

The RSX-1055 has two digital outputs (one coaxial and one optical) to send the digital signal from any of the five digital inputs to a digital recorder or outboard digital processor. When a digital input source signal is selected for listening, that signal is automatically sent to both digital outputs for recording or outboard processing.

---

**NOTE:** Only digital signals from source components are available at these outputs. Analog signals cannot be converted and are not available at the digital outputs.

---

Connect the digital output to the digital input of your recorder or processor. You can use either a 75 ohm coaxial video cable or an optical cable.

## Output Signal Connections

See Figure 3.

This section of the manual describes the audio and video signal output connections on the RSX-1055. These are used for routing the output signals to television monitors, audio amplifiers, and recording devices.

### TV Monitor Output 30 42

The video output of the RSX-1055 sends the video signal to your TV monitor. Three types of video output connections are provided – RCA composite video, S-Video, and Component Video. Choose the type of video output connection that matches the type of video input connections you have made. Connect the TV MONITOR output, from either RCA composite or S-Video or Component Video connector, to the corresponding input on your television monitor, using appropriate video cables.

**NOTE:** The RCA composite video output only sends signals from RCA composite video source inputs to the TV monitor. The S-Video output only sends signals from S-Video video source inputs to the TV. The Component Video output only sends signals from Component Video source inputs to the TV. If you have connected all of your source components with the same type of connection, then you only need to make one connection from the RSX-1055 to the TV monitor. However, in a mixed system with, for example, some S-Video and some RCA composite inputs, you will need to make two connections to the TV monitor and use its input selector to switch between the two when changing sources.

**NOTE:** The ON-SCREEN DISPLAY system is not available when using Component Video connections to the TV monitor

### Speaker Outputs 31

The RSX-1055 has five built-in amplifiers, two for the front (right and left), one for the center channel, and two for the rear surround speakers (right and left). There are five pairs of binding post connections (one pair for each speaker) which accept bare wire, spade lugs, or banana plug connectors (in some markets).

Each pair of connectors is color-coded for polarity: red/blue/green for positive and black for negative. All speakers and all speaker wire is also marked for polarity. For proper perfor-

mance, you must maintain this polarity at all speaker connections. Always connect the positive terminal of each speaker to the corresponding colored (red/blue/green) speaker terminal on the RSX-1055 and the negative speaker terminal to the corresponding black connector on the RSX-1055.

Each pair of connectors is labeled (FRONT L, FRONT R, SURROUND L, SURROUND R, and CENTER). You must connect each of the five speakers to the proper terminal on the RSX-1055.

Route the wires from the RSX-1055 to the speakers. Leave enough slack so you can move the components to allow access to the speaker connectors. If you are using banana plugs, connect them to the wires and then plug into the backs of the binding posts. The collars of the binding posts should be screwed in all the way (clockwise). If you are using terminal lugs, connect them to the wires. If you are attaching bare wires directly to the binding posts, separate the wire conductors and strip back the insulation from the end of each conductor. Be careful not to cut into the wire strands. Unscrew the binding post collars. Place the connector lug or the twisted bare wire around the binding post shaft. Turn the collars clockwise to clamp the connector lug or wire firmly in place.

**NOTE:** Be sure that no loose wire strands can touch adjacent wires or connectors.

### Center Back Speakers

The RSX-1055 has a “redirect” feature that allows you to use the front left and front right amplifier channels to power center back speakers. For example, you might use a high-performance separate Rotel stereo power amplifier to drive the front speakers and use the five RSX-1055 internal amplifier channels to power the center, right surround, left surround, and center back speakers.

To use this feature, connect the left and right center back speakers to the front left and front right speaker connections on the RSX-1055 rear panel. If you only have one center back speaker, connect it to L/1 front speaker position and leave the other set of front connections unused. Then, go to the SPEAKER SETUP screen of the ON-SCREEN MENU system and change the REDIRECT line to Center Back (CB SP) instead of FRONT SP.

### Preamp Outputs 20

There are ten RCA preamp audio outputs: FRONT (LEFT/ RIGHT), CENTER (1/2), SURROUND REAR (LEFT/RIGHT), CENTER BACK (CB1/CB2), and SUBWOOFER (1/2). Use these outputs to send the RSX-1055's output signals to powered speakers or external amplifiers used in place of one or more of the internal amplifiers.

**NOTE:** Depending on your system configuration, you may use some or all of these connections. For example, if you only have one center channel, you would connect it to the CENTER 1 output. If you only have one center back channel, you would connect it to the CB1 output.

**To hook up a powered subwoofer,** connect a standard RCA audio cable from the SUBWOOFER OUTPUT jack to the input on the subwoofer's power amp.

**To hook up the RCA main audio outputs,** connect an audio cable from each output to the input of the amplifier channel that will power the corresponding speaker. In a full home theater system, you will need to make six different connections corresponding to the six speakers (left front, center front, right front, left surround, right surround, and subwoofer).

Make sure that you have each output connected to the correct amplifier channel (front right, left rear, etc.).

## Antenna Connections

See Figure 6.

The RSX-1055 requires two antennas to receive radio signals, one for AM and one for FM. Most users will get acceptable reception using the indoor antennas which are supplied with the RSX-1055. Instructions for hooking up these antennas follow.

**NOTE:** If you are some distance from the radio transmitters, you may use an outdoor antenna to improve reception. Outdoor antenna systems can be dangerous if they are not properly grounded and should be installed by a professional contractor familiar with the electrical code requirements in your local area.



## AM Antenna 22

The RSX-1055 includes a plastic loop antenna to receive AM radio signals. Remove this antenna from the box and locate it near the RSX-1055. It can be tacked to a wall, using the mounting tab provided. Alternatively, you can fold the center portion of the antenna to form a tabletop stand.

Connect the 300 ohm twin-conductor wire from the loop antenna to the pair of screw terminals labeled AM LOOP, attaching one wire to each terminal. It does not matter which wire attaches to which terminal, but make sure that the connections are solid and that the two wires do not touch.

You may need to rotate or otherwise reorient the antenna to find the best position.

---

**NOTE:** To use an outdoor antenna, connect its 300 ohm twin-conductor wire to the terminals in place of the loop antenna.

---

## FM Antenna 21

The RSX-1055 is supplied with a T-shaped indoor FM antenna. Connect the coax F-type plug to the FM antenna connector on the RSX-1055. For best reception, unfold the T-shaped antenna. Eyelets at both ends of the T allow tacking the antenna to a wall, if desired. Experiment with positioning for best reception.

---

**NOTE:** To use an outdoor antenna, connect its 75 ohm coax lead wire to the FM connector instead of the indoor wire antenna, only after a professional contractor has installed the antenna system in accordance with local electrical codes.

---

# Power and Miscellaneous Connections

## AC Input 43

Your RSX-1055 is configured at the factory for the proper AC line voltage in the country where you purchased it (USA: 115 volts/60Hz AC or CE: 230 volts /50 Hz AC ). The AC line configuration is noted on a decal on the back of your unit.

Plug the supplied cord into the AC INPUT receptacle on the back of the unit.

See the POWER SWITCH heading in the BASIC CONTROLS section of this manual for information about turning the unit on and off.

---

**NOTE:** Memorized settings and video labels will be stored for up to one month if the RSX-1055 is disconnected from AC power.

---

## 12V TRIGGER Connections 26

Several Rotel amplifiers offer the option of turning them on and off using a 12 volt trigger signal. These two connections provide this 12 volt trigger signal. When the RSX-1055 is activated, a 12 volt DC signal appears at these connectors and will turn on amplifiers. When the RSX-1055 is put in STANDBY mode, the trigger signal is interrupted and the amplifiers will turn off.

## EXTERNAL REM IN 27

This 3.5 mm mini-jack (labeled EXT REM IN) receives command codes from an industry-standard infrared receivers (Xantech, etc.) located in the main listening room. This feature is useful when the unit is installed in a cabinet and the front-panel sensor is blocked. Consult your authorized Rotel dealer for information on external receivers and the proper wiring of a jack to fit the mini-jack receptacle.

---

**NOTE:** The IR signals from the EXTERNAL REMOTE IN jack (as well as those from the ZONE REMOTE IN jack) can be relayed to source components using external IR emitters or hard-wired connections from the IR OUT jacks. See the ZONE 2 section of this manual for additional information.

---

## Computer I/O 33

The RSX-1055 can be operated from a computer with audio system control software from third-party developers. This control is accomplished by sending operating codes from the computer via a hard-wired RS-232 serial connection. In addition, the RSX-1055 can be updated using special software from Rotel.

The COMPUTER I/O input provides the necessary network connections on the back panel. It accepts standard RJ-45 8-pin modular plugs, such as those commonly used in 10-BaseT UTP Ethernet cabling.

For additional information on the connections, cabling, software, and operating codes for computer control or updating of the RSX-1055, contact your authorized Rotel dealer.

# Zone 2 Connection and Operation

The RSX-1055 provides Zone 2 multi-room capability, allowing you to enjoy music and operate the system from a second room. From the remote location, you can select a source component (even if different from the source playing in the main listening room), adjust the volume level in the remote zone, and operate the source components.

To use the Zone 2 capability, you need additional components: a pair of speakers installed in the remote zone, an amplifier to drive them, and a third-party IR repeater system.

Zone 2 can be controlled from the main room using RSX-1055's front-panel ZONE button. Operation from the remote zone requires the installation of an infrared repeater system (Xantech, Niles, etc.) which relays infrared remote control commands from Zone 2 to the ZONE REMOTE IN input on the back of the RSX-1055.

Several points to keep in mind about the Zone 2 function:

- An infrared repeater system (Xantech, Niles, etc.) is required for operation from the remote zone.
- There are two options for the Zone 2 output level, selectable from the ON-SCREEN DISPLAY menu system. VARIABLE output gives you full adjustment of the volume level, remembering the previous setting whenever Zone 2 is activated. FIXED output disables the Zone 2 volume control with the output permanently set to a specified level. This might be useful for sending a line level signal to a preamp or integrated amp with its own volume control or to a distribution amplifier with multiple volume controls.
- The RR-969 remote control supplied with the RSX-1055 will operate Zone 2 if used with a repeater system from the remote zone. It can also be programmed to operate Rotel source components via the RSX-1055's IR OUT jack.
- Any source component connected to the RSX-1055's inputs can be sent to the Zone 2 outputs. ZONE 2 operates independently of the main room. You can select a different source or adjust Zone 2 volume without affecting the MAIN outputs in any way.

- Avoid sending the same infrared command to the RSX-1055 front-panel sensor and a Zone 2 repeater at the **same** time. This means that Zone 2 **must** be in a different room from the RSX-1055.

## Zone 2 Power On/Off Operation

Once master power is applied to the unit by pressing the front-panel POWER button, the RSX-1055 provides independent power on/off operation for both zones. Pressing the remote control POWER button in the main room activates or deactivates the RSX-1055 in the main room only and has no effect on Zone 2. Conversely, activating or deactivating Zone 2 has no effect on the main listening room. However, placing the front-panel POWER button in the OFF position completely shuts off the unit, for both zones.

**NOTE:** For proper power on and off operation with Zone 2, the RSX-1055's power mode should be set to the factory default DIRECT setting or to the STANDBY setting using the OTHER OPTIONS menu from the ON-SCREEN DISPLAY.

## Controlling Zone 2 from the Main Room ZONE Button

You can control Zone 2 from the front-panel of the RSX-1055 – activate or deactivate Zone 2, change input sources, and adjust the volume. Controlling Zone 2 from the front-panel is accomplished by pressing the ZONE button, which temporarily puts the RSX-1055 in Zone 2 control mode, even if the unit is in standby mode. When the ZONE button is pressed, the FL DISPLAY shows the current status of ZONE 2 for ten seconds, during which time you can use the VOLUME control and INPUT SOURCE buttons to change the ZONE 2 settings. When ZONE 2 is active, the ZONE indicator in the FL DISPLAY lights.

### To turn Zone 2 on or off:

1. Press the front-panel ZONE button. The status of Zone 2 appears in the display. If Zone 2 is in standby, "ZONE OFF" appears. If Zone 2 is active, "ZONE xxxxx" showing the current input source appears.
2. If Zone 2 is ON, pressing the ZONE button a second time within 10 seconds turns it OFF. If Zone 2 is OFF, the second press of the ZONE button turns it ON with the last used input source and volume setting.
3. Following 10 seconds with no commands, the RSX-1055 reverts to normal operation.

### To change the Zone 2 input source:



1. Press the front-panel ZONE button. The status of Zone 2 appears in the display. Make sure that Zone 2 is ON.
2. Within 10 seconds after pressing the ZONE button, press one of the INPUT SOURCE buttons to select a new source for Zone 2. The name of the selected source appears in the display.
3. Following 10 seconds with no commands, the RSX-1055 reverts to normal operation.

### To change the Zone 2 volume:

1. Press the front-panel ZONE button. The status of Zone 2 appears in the display. Make sure that Zone 2 is ON.
2. Within 10 seconds after pressing the ZONE button, adjust the volume control to change the Zone 2 output level. The new setting appears in the display.
3. Following 10 seconds with no commands, the RSX-1055 reverts to normal operation.

## Controlling Zone 2 from the Remote Location

With a properly configured IR repeater system, you have full control of Zone 2 using an RR-969 remote from the Zone 2 location. You can select and operate a source, adjust the volume, and turn Zone 2 on or off. Whatever commands you send from the RR-969 will change Zone 2 and only Zone 2, just as if you were controlling a totally independent audio system in that room. These changes will have no effect on the main listening room.

To turn Zone 2 on or off, press the POWER button  on the remote. To adjust the volume in Zone 2, press the VOLUME buttons  on the remote. To select a different analog input source, press one of the INPUT SOURCE buttons  on the remote.

**When the TUNER source is not selected in the main room,** you can also access the tuner functions (Preset, Tuning Up/Down, Direct Preset Channel Selection, etc.) from ZONE 2. This feature is not available when the TUNER source is active in the main room to avoid interrupting someone else's listening by changing the station.

**NOTE:** The volume adjustment is only available if the Zone 2 outputs are configured to use VARIABLE levels. With FIXED levels, the volume control for Zone 2 is disabled.

## Zone 2 Audio Outputs

See Figure 5.

These line-level RCA outputs send the Zone 2 audio signals to a stereo amplifier driving a pair of speakers in the remote zone.

**NOTE:** Only analog input signals are available at the Zone 2 outputs. Source components connected to only the digital inputs are not available in Zone 2.

Although you have the option of using an integrated amplifier or a receiver to power the remote speakers, we suggest using a fixed-gain power amplifier. This simplifies system installation and operation. Your authorized Rotel dealer may make another recommendation based on specific system requirements.

To configure your system for Zone 2 operation, connect the left and right Zone 2 outputs on the RSX-1055 to the left and right channel inputs of the amplifier powering the remote speakers, using standard RCA audio cables.

**NOTE:** By default, the Zone 2 outputs provide a VARIABLE level signal, with control of the volume from the RSX-1055 front-panel and/or remote control from Zone 2. Alternatively, you can configure these outputs for FIXED level, which disables the volume control and sends a fixed line-level signal to an amplifier with its own volume control. See the ON-SCREEN DISPLAY/Configuration section for details.

## ZONE REM IN Jack 25

See Figure 5.

This 3.5 mm mini-jack accepts signals from an infrared repeater located in Zone 2. This IR repeater system is required for operation of the RSX-1055's ZONE 2 functions from the remote zone. There are many available IR repeater systems from third-party suppliers and it is impractical to cover the wiring of each type in this manual. Please consult your authorized Rotel dealer for information on configuring an IR repeater system for your application.

**NOTE:** ZONE 2 and its IR repeater must be in a different location than RSX-1055 to prevent IR commands intended to control Zone 2 from inadvertently controlling the main room operations.

**NOTE:** The EXT REM IN jack located to the right of this jack is for use with an external IR sensor duplicating the front-panel IR sensor and located in the primary zone. It should **not** be used for ZONE 2 IR connections.

## IR OUT Jacks 24

See Figure 5.

The IR OUT 1 & 2 jacks send IR signals received at the ZONE REM IN jack or the EXTERNAL REM IN jack to an infrared emitter placed in front of a source component or to Rotel CD players, DVD players, or tuners with a compatible rear panel IR connector.

This output is used to allow IR signals from Zone 2 to be sent to the source components, or to pass along IR signals from a remote in the main room when the sensors on the source components are blocked by installation in a cabinet. See your authorized Rotel dealer for information on IR repeater systems.

## On-Screen Display and System Configuration

The RSX-1055 features two on-screen systems to help operate the system. The first consists of simple status displays that appear on the TV screen whenever primary settings (Volume, Input, etc.) are changed. These status displays are self-explanatory.

A more comprehensive ON-SCREEN DISPLAY menu system is available at any time by pressing the MENU button on the remote control. These menus guide you through the setup and operation of the RSX-1055.

**System Set-Up:** System setup should be done while using a Composite video or S-Video cable connecting the RSX-1055 TV MONITOR outputs to the video input of the TV or projector. No other video connections should be made at this time. Select OSD (ON-SCREEN MENU) from the RR-969 remote control to complete system setup.

**NOTE:** On a PAL standard monitor, the OSD cannot be displayed until a video signal is present, irrespective of the type of video cables in use. For setup, connect the Composite video output from your DVD player and select its input on the RSX-1055. The OSD will be displayed as an overlay to the video signal from the DVD player.

The ON-SCREEN MENU system can be configured to display several different languages. The default English version of all the menus is shown at the front of this manual. If your language is available, those menus will be shown in the following instructions. If you would like to change from the default English language before proceeding, go to the instructions for the OTHER OPTIONS menu later in this manual. From this menu, you can change the language display.

## Navigation Buttons

**D Q R S**

The following remote control buttons are used to navigate the ON-SCREEN DISPLAY menu system:

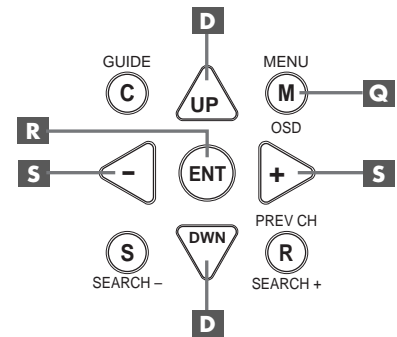

**MENU Button Q:** To display the MAIN screen. All other menus are reached from this menu. If a menu is already visible, push this button to cancel the display.

**DOWN/UP Buttons D:** To move up and down in the lists that appear on the ON-SCREEN DISPLAY menu system.

**+/- Buttons S:** To change the current settings for a selected menu choice on some menus in the ON-SCREEN DISPLAY menu system.

**ENTER Button R:** To confirm a setting and return to the MAIN menu.

**NOTE:** A help system at the bottom of each ON-SCREEN DISPLAY menu reminds you which buttons to press.

## SYSTEM STATUS Menu

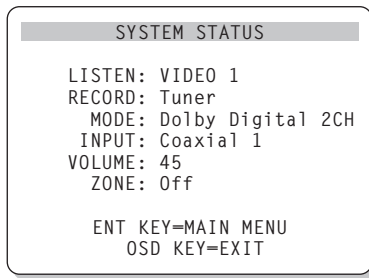

The SYSTEM STATUS menu provides a snapshot of the current system settings and a starting point for reaching all other screens and menus. This screen appears when you press the MENU button on the remote control and displays the following information:

**LISTEN:** the source selected for listening.

**RECORD:** the source selected for the VIDEO and AUDIO outputs.

**MODE:** the current surround sound mode.

**INPUT:** the input selected for the current source: Optical, Coaxial, Analog, etc.

**VOLUME:** the current volume setting.

**ZONE:** the current status of ZONE 2, ON or OFF.

No changes can be made using this screen; it only provides information. To go to the rest of the menus, press the ENTER button to go to the MAIN menu. Press the MENU key on the remote to cancel the display and return to normal operation.

**NOTE:** The SYSTEM STATUS screen appears for ten seconds when the unit is turned on and automatically turns off.

## MAIN Menu

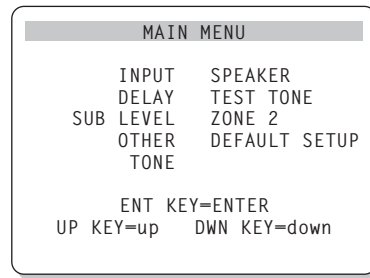

The MAIN menu provides access to nine other screens for various configuration options and is reached by pressing the ENTER button from the SYSTEM STATUS menu described above or from most other menus. To go to another menu, move the highlight to the desired line using the UP/DOWN buttons on the remote and press the ENTER button. Press the MENU key on the remote to cancel the display and return to normal operation.

## INPUT Menu

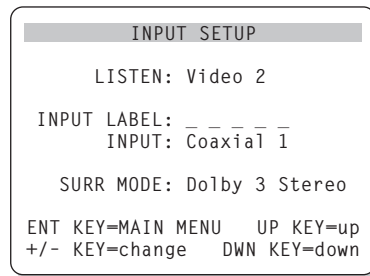

The INPUT SETUP menu configures the source inputs and is reached from the MAIN menu. The screen provides the following options, selected by placing the highlight on the desired line using the UP/DOWN buttons:

**LISTEN:** changes the current listening input source (CD, TUNER, TAPE, VIDEO1, VIDEO2, VIDEO3, VIDEO4, VIDEO5).

**INPUT LABEL:** The labels for the five VIDEO inputs can be customized (not available for the TUNER, CD, and TAPE inputs). Place the highlight on this line to call up a sub-menu that allows you to change the five-character label for the current VIDEO source. To change the label:

1. Press the +/- keys to begin labeling.
2. Press the +/- keys to change the first letter, scrolling through the list of available characters.

3. Press the ENT key to confirm that letter and move to the next position.
4. Repeat steps 2 and 3 until all five characters have been completed. The final press of the ENT button will save the new label and exit the sub-menu.

**INPUT:** selects which physical input connection to use as the default for the source displayed in the first line of the menu. The options are ANALOG inputs, two OPTICAL digital inputs (OPTICAL 1 & 2), and three COAXIAL digital inputs (COAXIAL 1 – 3). When a digital input is selected, the unit will check for a digital signal when the INPUT SOURCE button is pressed. If no digital signal is present, the unit will automatically revert to the analog input. When an ANALOG input is selected, the unit will not access a digital signal, even though one may be present at the digital input; thus, the ANALOG setting forces the unit to use accept only an analog signal. Assigning a digital input (with its auto-sensing) is the preferred configuration for digital source inputs such as DVD players.

**NOTE:** If a source connected to a digital input is selected, that signal will automatically be sent to both digital outputs for recording.

**SURR MODE:** selects the default surround sound mode for the input shown at the top of the menu. The default setting will be used unless the source material triggers automatic decoding of a particular type or unless the default setting is overridden by the front panel or remote surround buttons. Options are: Stereo, Dolby Pro Logic II, Dolby 3-Stereo, Music 1 – 4, 5CH Stereo, 7CH Stereo, and DTS Neo:6.

This is a default setting for each input and, in some cases, can be manually overridden by the front-panel MODE buttons or the SUR+ button on the remote. See the SURROUND SOUND CONTROLS section of this manual for more information on which settings can be overridden.

**NOTE:** The following types of discs or source material are generally detected automatically and the proper decoding activated with no action or setting required: DTS, DTS-ES Matrix 6.1, DTS-ES Discrete 6.1, Dolby Digital, Dolby Digital Surround EX, Dolby Digital 2-channel, PCM 2-Channel, MP3, and HDCD.

Two of the default surround mode settings available on this menu offer additional choices. Dolby Pro Logic II decoding offers a choice

of CINEMA, MUSIC, or EMULATION settings. DTS Neo:6 decoding offers a choice of CINEMA or MUSIC settings. When either Dolby Pro Logic II or DTS Neo:6 is selected with this menu item, the current setting choice will also be displayed. In addition, the function of the ENTER button changes, taking you to a sub-menu where you can change the settings and/or additional parameters for Dolby Pro Logic II or DTS Neo:6 decoding. See the following section for details.

To return to the MAIN menu (except when Dolby Pro Logic II or DTS Neo:6 is selected in the SURR MODE field), press the ENTER button. Press the MENU key on the remote to cancel the menu display and return to normal operation.

**NOTE:** We suggest that you return to this menu after connecting each source component to properly configure that source.

## DTS Neo:6 Sub-Menu DOLBY PRO LOGIC II Sub-Menu

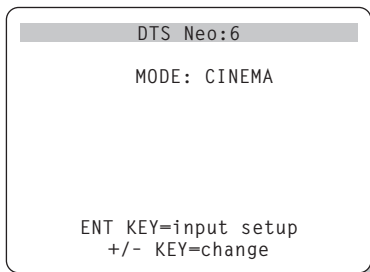

When Dolby Pro Logic II or DTS Neo:6 is selected as the default surround mode on the INPUT SETUP menu (see previous section), there are additional option settings and parameters available to optimize the surround decoding for various types of recordings, music or movie soundtracks.

These settings are changed using one of the DOLBY PRO LOGIC II or DTS Neo:6 sub-menus, reached by pressing the ENTER key from the INPUT SETUP menu when either of these surround modes is selected.

The sub-menu will be similar to the example shown above, with the title at the top of the screen indicating either DOLBY PRO LOGIC II or DTS Neo:6 depending on the surround mode.

**In DTS Neo:6 surround mode,** there will only be one choice available on the sub-menu: selecting CINEMA or MUSIC modes. Use the +/- keys on the remote to change the settings.

- Select CINEMA to optimize the DTS Neo:6 decoding for movie soundtracks.
- Select MUSIC to optimize the DTS Neo:6 decoding for musical recordings.

**In Dolby Pro Logic II surround mode,** there will a similar choice available on the sub-menu except that there are three options: CINEMA, MUSIC, or EMULATION modes. Use the +/- keys on the remote to select a mode.

- Select CINEMA to optimize for Dolby Surround encoded movie soundtracks, using the enhanced matrix decoding of Dolby Pro Logic II including increased surround separation and full-bandwidth surround channel frequency response.
- Select EMULATION decoding logic that emulates the original Dolby Pro Logic system. You may prefer this option for older movie soundtracks that are not of optimum audio quality. EMULATION mode reduces the high-frequency response and separation of the surround channels and may increase the delay setting to the surround channels for a more spacious effect.
- Select MUSIC to optimize for musical recordings. When the MUSIC mode is selected, three additional parameter will be available as shown in the following screen:

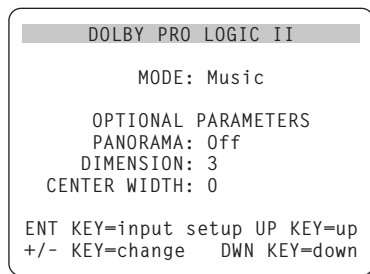

Use the UP/DOWN keys on the remote to select a parameter. Use the +/- keys to change the selected parameter as follows:

- **PANORAMA:** The Panorama option extends the front stereo image to include the surround speakers for a dramatic “wrap-around” effect. The options are OFF or ON.
- **DIMENSION:** The Dimension option allows you to gradually adjust the soundfield towards the front or towards the rear. There

are seven incremental settings from 0 to 6. A setting of 0 shifts the soundfield towards the rear for maximum surround effect. A setting of 6 shifts the soundfield to the front for minimum surround effect. The default setting of 3 provides a “neutral” balance between the two extremes.

- **CENTER WIDTH:** The Center Width option allows you to spread the signal intended for the center speaker to the left and right front speakers, widening the perceived soundfield. There are eight incremental settings from 0 to 7. With the default setting of 0, there is no center width spreading and all of the center channel information is sent to the center speaker. The maximum setting of 7 shifts all of the center channel signal to the left and right speakers, essentially muting the center speaker and maximizing the soundfield width. Other settings provide incremental steps between the two extremes.

When you have completed all the desired adjustments, press the ENTER key to return to the INPUT SETUP menu.

## SPEAKER SETUP Menu

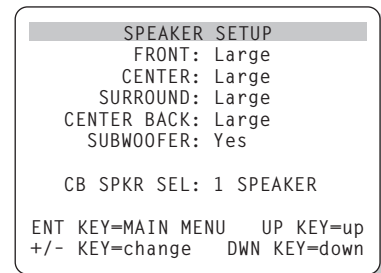

The SPEAKER SETUP menu is used to configure the RSX-1055 for use with your specific loudspeakers. The menu is accessed from the MAIN menu.

Home theater systems vary in the number of speakers and the bass capabilities of those speakers. The RSX-1055 offers surround modes tailored to systems with various numbers of speakers and bass management features which send bass information to the speaker(s) best able to handle it – subwoofers and/or large speakers. For optimum performance, you must tell the RSX-1055 the number of speakers in your system and how bass should be distributed among them.

**NOTE:** There are two types of bass in a surround system. The first is normal bass recorded in each of the main channels (front, center, and surround). This bass is present in all recordings and soundtracks. In addition, Dolby Digital 5.1 and DTS 5.1 recordings have a Low Frequency Effects (LFE) channel – the .1 channel. This bass channel, typically played by a subwoofer, is used for effects such as explosions or rumble. The use of the LFE channel will vary from soundtrack to soundtrack. Recordings that are not encoded in Dolby Digital or DTS do not have the LFE channel.

The following configuration instructions refer to LARGE and SMALL speakers, referring more to their desired bass configuration than their physical size. Specifically, use the LARGE setting for speakers that you want to play deep bass signals. Use the SMALL designation for speakers that would benefit from having their bass sent to more capable speakers. The bass management system redirects bass information away from all SMALL speakers and sends it to the LARGE speakers and/or the SUBWOOFER. It may be useful to think of LARGE as “full-range” and SMALL as “high-pass filtered.”

Four typical examples of the many possible system configurations illustrate the principles behind bass management:

- A system with five LARGE speakers and a subwoofer: This system requires no bass redirection. All five speakers play the normal bass recorded in their respective channels. The subwoofer plays **only** the LFE channel bass. This may not be the most efficient use of system resources. Depending on the soundtrack, there may be minimal use of the LFE channel, so the subwoofer would be underutilized. Meanwhile the normal bass places higher demands on the capabilities of the other speakers and the amplifiers driving them.
- A system with LARGE front, center, and surround speakers, but no subwoofer. The normal bass from the front, center, and surround channels is played in its respective speakers. With no subwoofer, the LFE bass is redirected to all five LARGE speakers. This places significant demands on these speakers and their amplifiers, as they must play their own normal bass plus the very demanding LFE bass.

- A system with LARGE front speakers, SMALL center and surround speakers, and a subwoofer. The normal bass from the SMALL center and surround speakers is redirected to the LARGE front speakers and the subwoofer. The LARGE front speakers play their own normal bass plus the redirected bass from the SMALL speakers. The subwoofer plays the LFE bass plus some of the redirected bass from the SMALL center and surround channels. This might be an appropriate configuration with a pair of very capable front speakers driven by a large separate power amplifier.
- A system with all SMALL speakers and a subwoofer. The normal bass from all channels is redirected to the subwoofer, which also plays the LFE bass. The subwoofer handles ALL of the bass in the system, while the other speakers benefit from the added dynamic range and reduced strain of not having to play low bass. This configuration realizes the full benefits of bi-amping: bass is played by the speaker most suited to do so, the other speakers play louder with less distortion, and the need for amplifier power is reduced. This is the most popular home theater configuration and should be strongly considered even if the speakers are physically large and capable of playing low bass. This configuration is particularly advantageous when driving the speakers with moderate power amplifiers.

**NOTE:** As an alternative configuration with a satellite/subwoofer package as the front speakers, follow the speaker manufacturer’s instructions, connecting the high-level inputs of the powered subwoofer directly to the front speaker outputs of the RSX-1055 and connecting the satellite speakers to the subwoofer’s own crossover. In this arrangement, the speakers would be classified as LARGE and the subwoofer setting would be OFF for all surround modes. No information is lost during playback because the system redirects bass information to the front LARGE speakers. While this configuration ensures proper satellite speaker operation by using the speaker’s own crossovers, it has some disadvantages in terms of system calibration.

The following speaker options are available:

**FRONT SPEAKERS (small/large):** Use the LARGE setting to have the front speakers play low bass (full-range). Use the SMALL setting to redirect normal bass away from these speakers to a subwoofer (high-pass filtered).

**CENTER SPEAKER(S) (small/large/none):** Use the LARGE position (not available with SMALL front speakers) to have the center speaker play low bass (full-range). Use the SMALL position if your center channel speaker has more limited low frequency capability, or if you prefer that the bass be sent to the subwoofer (high-pass filtered). Select the NONE setting if your system does not have a center channel speaker (the surround modes will automatically divide all center channel information equally between the two front speakers, creating a phantom center channel).

**SURROUND SPEAKERS (small/large/none):** Select the LARGE setting (not available with SMALL front speakers) to have the surround speakers play low bass (full-range). If your rear speakers have limited bass capability or if you would prefer that the bass go to a subwoofer, use the SMALL setting (high-pass filtered). If your system has no rear surround speakers, select the NONE setting (surround channels are added to the front speakers so none of the recording is lost).

**CENTER BACK SPEAKER(S) (small/large/none):** Some systems have one or two additional center back surround speakers for use with 6.1 channel surround signals or 7CH stereo processing. With the RSX-1055, such a configuration is available using the preamp outputs and external amplifiers. Select the LARGE setting (not available with SMALL front speakers) to have your center back speakers play low bass (full-range). If your side speakers have limited bass capability or if you would prefer that the bass go to a subwoofer, use the SMALL setting (high-pass filtered). If your system has no center back speakers, select the NONE setting. With center back speakers, the Rotel XS extended surround and/or other decoders will provide center back signals for any surround mode.

**SUBWOOFER (yes/no/max):** The YES setting is the standard setting if your system has a subwoofer. If your system does not have a subwoofer, select NO. Select the MAX setting for maximum bass output with normal bass being duplicated by both the subwoofer and any LARGE speakers in the system.

**NOTE:** Generally the MAX setting (sometimes called "plus" or "double" bass) would not be used in systems with a capable subwoofer. Duplicating bass in LARGE speakers and the subwoofer can introduce room cancellation problems and make proper subwoofer level calibration difficult. If you need more bass output, a better option would be to use the normal YES setting and experiment with corner placement of the subwoofer.

**CB SPKR SELECT (1 speaker/2 speakers):** Use the 1 SPEAKER setting if your system has a single center back surround speaker. Use the 2 SPEAKERS setting if your system has 2 center back surround speakers. If your system does not have any center back speakers, select NONE on the previously described CENTER SPEAKER setting on this menu.

**NOTE:** Speaker configuration is a global setting for all surround modes and need only be done once.

To change a setting, place the highlight on the desired line using the UP/DOWN buttons and use the +/- buttons to toggle through the available settings. To return to the MAIN menu, press the ENTER button. Press the MENU key on the remote to cancel the display and return to normal operation.

## TEST TONE Menu

TEST TONE	
LEFT:	0dB
CENTER:	0dB
RIGHT:	0dB
R SURROUND:	0dB
CENTER BACK:	0dB
L SURROUND:	0dB
SUBWOOFER:	0dB
ENT KEY=MAIN MENU    UP KEY=up	
+/- KEY=change    DWN KEY=down	

This menu uses pink noise test tones to set equal volume levels for all speakers (left front, center, right front, right surround, center back, left surround, and subwoofer) to ensure proper surround sound reproduction. Setting the output levels using the test procedure provides the most accurate adjustment so that digital surround sound material will be reproduced as it was intended and is a critical step in calibrating the system.

**NOTE:** If you have configured your system to use two center back speakers, there will be an additional line in the menu, giving you the ability to independently adjust the CENTER BACK 1 and CENTER BACK 2 speakers.

To access this menu and perform the test tone calibration, you must be in one of the surround modes. To do this, press any of the MODE buttons except 2CH. Then, enter the ON-SCREEN DISPLAY menu system and select TEST TONE from the MAIN menu to reach this screen.

When you enter the TEST TONE menu, you will hear a test tone coming from the highlighted speaker. Highlight different speakers by moving the cursor to the desired line using the UP/DOWN buttons. The test tone will shift accordingly to the selected speaker.

Seated in the normal listening location, shift the test tone to the various speakers. Using the one speaker as a reference, listen for any speakers that are noticeably louder or quieter. If so, adjust that speaker's levels up or down (in 1dB increments) using the +/- buttons. Continue switching among the speakers and adjusting until all speakers are the same volume.

To return to the MAIN menu, press the ENTER button. Press the MENU key on the remote to cancel the menu display and return to normal operation.

## Calibration with an SPL meter:

Calibrating the system with an SPL meter, rather than by ear, provides more precise results and improves the system's performance significantly. Inexpensive SPL meters are widely available and the procedure is quick and easy.

Both Dolby and DTS specify a standard calibration level for all theaters to ensure that soundtracks can be played at the volume level intended by the director of the film. This reference level should result in spoken dialog played at about 80 dB (a realistic level for normal speech) with the loudest peaks in any single channel at about 105 dB.

This calibration can be done in a home theater using a sound pressure level (SPL) meter and the pink noise test tones described above. Set the meter to its SLOW response with C-weighting and hold it away from your body at your listening position (mounting the SPL meter on a camera tripod makes this easier). You can either point the SPL meter at each

speaker as it is being measured or leave the meter in a fixed position pointing at the ceiling.

Increase the master volume control on the RSX-1055 until the meter reads 75dB when playing the test tone through one of the front speakers. Then, use the individual channel adjustments on the TEST TONE menu to adjust each of the individual speakers, including the subwoofer, to the same 75dB on the SPL meter.

**NOTE:** Due to meter weighting curves and room effects, the actual level of the subwoofer may be slightly higher than you measure. To compensate, Dolby suggests setting the subwoofer several dB lower when calibrating with an SPL meter (i.e. set the subwoofer to read 72 dB on the meter instead of 75 dB). Avoid setting the subwoofer level too high. Exaggerated bass effects come at the expense of proper blending with the main speakers. If you can localize bass from the subwoofer, the subwoofer level is probably too high.

Remember the setting of the master volume control used during this calibration. To play a Dolby Digital or DTS soundtrack at the reference volume level, simply return to that volume setting. The idea of a reference volume setting to be used in every theater has its merits. However, many home theater listeners find this setting to be excessively loud. Let your own ears be the judge for deciding how loud to playback movie soundtracks. Regardless of your listening levels, using an SPL meter to calibrate equal levels for all speakers in the system is well worth the effort.

## DELAY SETUP Menu

DELAY SETUP		
	Dolby D	Dolby
	/DTS	Pro LogicII
CENTER:	1ms	
R SURROUND:	15ms	25ms
L SURROUND:	15ms	25ms
CNTR-BACK:	15ms	25ms
ENT KEY=MAIN MENU    UP KEY=up		
+/- KEY=change    DWN KEY=down		

This menu, which is reached from the MAIN menu, allows you to set the delay for individual speakers. This ensures that the sound from each speaker arrives simultaneously at the listening position, even when the speakers are not all placed at equal distances from the listener.

Although personal preference is the ultimate guide, you typically increase the delay to speakers located closer to the seating area and decrease the delay to speakers located farther from the seating area.

Start by measuring the distance from your seating position to each speaker. The speaker farthest away should receive no additional delay. Each of the other speakers will receive one millisecond of delay for each foot (30 cm) closer to you than the farthest speaker. For example, if the left front speaker is farthest away at 13 feet and the left rear speaker is 8 feet away, you should add 5 milliseconds of delay to the left rear speaker. Continue setting delays for each speaker until you have compensated for each speaker that is closer to you than the farthest speaker.

The delay times for the surround speakers are set longer for Dolby Pro Logic II mode than in Dolby Digital/DTS mode. When you change delay setting for Dolby Digital/DTS, the delay time for Dolby Pro Logic II will automatically be set for MUSIC or CINEMA/EMULATION modes.

The available settings for the CENTER channel (Dolby Digital/DTS only) are 0ms, 1ms, 2ms, 3ms, 4ms, and 5ms. For SURROUND (Dolby Digital/DTS), the settings are 0ms, 5ms, 10ms, and 15ms. For SURROUND (Dolby Pro Logic II), the MUSIC mode settings are the same as the Dolby Digital/DTS settings. For SURROUND (Dolby Pro Logic II), the CINEMA/EMULATION mode settings are 10ms, 15ms, 20ms, and 25ms. For the CENTER BACK channel (Dolby Digital/DTS only), the settings are 0ms, 5ms, 10ms, and 15ms.

To change a setting, place the highlight on the desired line using the UP/DOWN buttons and use the +/- buttons to increase or decrease the delay setting. To return to the MAIN menu, press the ENTER button. Press the MENU key on the remote to cancel the display and return to normal operation.

## SUBWOOFER SETUP Menu

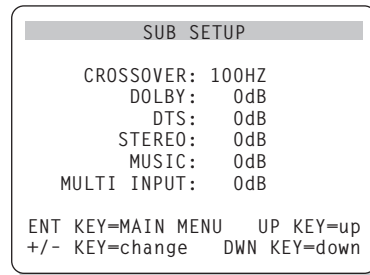

The SUBWOOFER SETUP menu allows selection of the subwoofer crossover frequency and independent adjustment of subwoofer level for each surround mode. These settings are memorized and engaged automatically each time a music or theater surround mode is selected.

When going to the SUBWOOFER SETUP menu from the MAIN menu, the current surround mode is automatically highlighted. Use the +/- buttons to adjust the subwoofer level (-10dB to +10dB) for the current surround mode.

**NOTE:** Only the current surround mode can be adjusted on this menu. You will need to change surround modes using the front-panel or remote buttons to adjust a different mode.

We recommend starting with the level settings for all surround modes at the default 0 dB setting during the test tone calibration of the system and for a period of familiarization after that. As you listen to a variety of source material over time, you may notice that certain surround modes consistently produce too much or too little bass from the subwoofer. Use these subwoofer level settings to adjust the relative bass output of various surround modes.

**NOTE:** In Dolby Digital and DTS recordings, the LFE channel is used to produce spectacular low bass effects. This LFE channel can generate output 10 dB louder than the other channels, placing considerable demands on your subwoofer system. If you hear distortion or other signs of distress from your subwoofer at loud listening levels, you may consider reducing the subwoofer level for the Dolby Digital and/or DTS surround modes. In other surround modes, there is no LFE channel and the subwoofer will only reproduce redirected bass from the other channels, which is not as likely to tax the subwoofer.

The CROSSOVER setting activates a low-pass filter for the subwoofer and a corresponding high-pass filter for all SMALL speakers in the system at the selected frequency. To adjust the crossover frequency, highlight the CROSSOVER line using the UP/DOWN buttons. Then, use the +/- buttons to choose one of the following options: OFF, 40Hz, 60Hz, 80Hz, 100Hz, or 120Hz. The 80Hz or 100Hz crossover points are the most common in home theater systems. However, your best setting depends on the specific speakers in your system.

**NOTE:** The OFF setting sends a full-range signal to your subwoofer so that you can use its built-in low-pass filter. With the OFF setting, a 100 Hz high-pass filter is activated for all SMALL speakers in the system.

To return to the MAIN menu, press the ENTER button. Press the MENU key on the remote to cancel the display and return to normal operation.

## TONE SETUP Menu

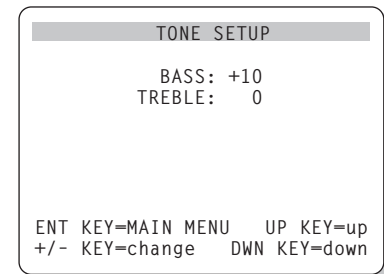

The TONE SETUP menu allows adjustment of the bass and treble settings.

Highlight the desired adjustment by moving the cursor to the desired line using the UP/DOWN buttons. Use the +/- buttons to increase or decrease the BASS or TREBLE setting. To return to the MAIN menu, press the ENTER button. Press the MENU key on the remote to cancel the display and return to normal operation.



## OTHER OPTIONS Menu

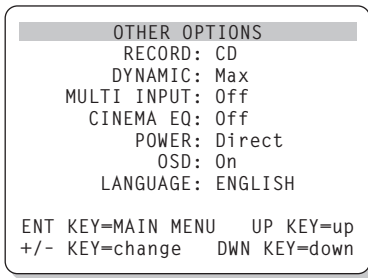

This menu, accessed from the MAIN menu, provides access to a several miscellaneous settings as follows:

**RECORD:** Select a signal for the record outputs by choosing one of the input sources.

**DYNAMIC:** steps through the three dynamic range settings available in digital modes:

- MAX (no compression/full dynamic range)
- MID (moderate compression)
- MIN (full compression/minimum dynamic range).

**MULTI INPUT:** determines whether the MULTI channel input is turned ON or OFF.

**CINEMA EQ:** determines if a special equalization setting is turned ON or OFF. This equalization may be desirable for playback of movie source material to compensate for the acoustic differences between a commercial cinema and a home theater environment. The CINEMA EQ setting can also be changed using the FILTER button on the remote.

**POWER:** This setting determines how the RSX-1055 powers up. With the default DIRECT setting, the unit is fully activated when AC power is applied and the front-panel POWER button is pressed in; however, it may be put in STANDBY mode using the remote POWER button. With the STANDBY setting, the unit powers up in standby mode when AC is applied and the front-panel POWER button is in the ON position. The unit must be activated using the remote control POWER button. In ALWAYS-ON mode, the unit remains fully active whenever AC is present and the front-panel POWER button is pressed in; the remote POWER button is disabled and the unit cannot be put in standby mode.

**OSD:** Determines whether the ON-SCREEN DISPLAYS are shown on your TV monitor during operation.

**LANGUAGE:** Selects a language for all of the ON-SCREEN MENUS.

Change settings on the OTHER OPTIONS menu by highlighting the desired line using the UP/DOWN buttons and using the +/- buttons to step through the available settings. To return to the MAIN menu, press the ENTER button. Press the MENU key on the remote to cancel the display and return to normal operation.

## DEFAULT SETUP Menu

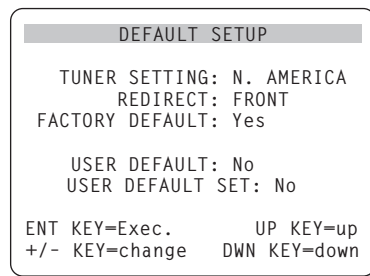
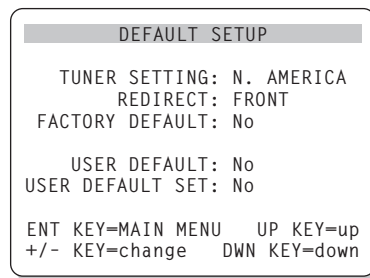

The DEFAULT SETUP menu provides access to five functions:

- Restoring all features and settings to the original FACTORY DEFAULT settings.
- Changing the tuning functions and displays for use in North America or Europe.
- Specifies whether the front left and front right internal amplifier channels are used to power front speaker (default setting) or center back speakers.
- Memorizing a custom group of settings as a USER DEFAULT.
- Activating the USER DEFAULT settings.

**To restore the FACTORY DEFAULT settings:** Place the highlight on the FACTORY DEFAULT line using the UP/DOWN buttons and use the +/- buttons to change the setting to YES. The screen will change to a confirmation screen. Press the ENTER button to proceed with resetting the FACTORY DEFAULT settings. The unit will power off and then on, with the factory settings restored. To return to the MAIN menu without resetting the FACTORY DEFAULT settings, change the entry to NO and press the ENTER button.

**NOTE:** Resetting to factory default settings will erase all stored settings including delay settings, speaker settings, balance settings, input settings and more. You will lose ALL system configuration settings. Be certain that you wish to do so before resetting the factory defaults.

**To change the TUNER setting:** Place the highlight on the TUNER SETTING line using the UP/DOWN buttons and use the +/- buttons to change the setting to N. AMERICA or EUROPE. Then, move the highlight to the FACTORY DEFAULT line and change the setting to YES as described above. The screen will change to a confirmation screen. Press the ENTER button to proceed with resetting the FACTORY DEFAULT settings and changing the TUNER SETTING. To return to the MAIN menu without resetting the FACTORY DEFAULT and TUNER settings, change the entry to NO and press the ENTER button.

**NOTE:** Changing the default TUNER SETTING can only done at the same time as restoring the FACTORY DEFAULT settings. Therefore, we recommend selecting your default TUNER SETTING and resetting to the FACTORY DEFAULT settings as the first step in configuring the unit, before you change or memorize any other configuration settings.

**To change the REDIRECT setting:** Place the highlight on the REDIRECT line using the UP/DOWN buttons and use the +/- buttons to change the setting to FRONT SP (for powering front speakers) or CB SP (for powering center back speakers). If you use the internal amplifiers to power center back speakers, then you will need a separate stereo amplifier to power your front speakers.

**To save USER DEFAULT settings:** Many of the current configuration settings can be stored as a USER DEFAULT, which can be activated at any time from this menu screen. To save the current settings as a USER DEFAULT, place the highlight on the USER DEFAULT SET line using the UP/DOWN buttons and use the +/- buttons to change the setting to YES. The screen will change to a confirmation screen. Press the ENTER button to store the new USER DEFAULT settings. To return to the MAIN menu without saving any changes, change all entries on the screen to NO and press the ENTER button.

**NOTE:** If there is insufficient memory to store a USER DEFAULT configuration file, the USER DEFAULT SET option will not be available.

**To activate memorized USER DEFAULT settings:** After you have stored a USER DEFAULT configuration file, you can activate those settings at any time by placing the highlight on the USER DEFAULT line using the UP/DOWN buttons. Use the +/- buttons to change the setting to YES. The screen will change to a confirmation screen. Press the ENTER button to proceed with activating the USER DEFAULT settings. To return to the MAIN menu without activating the USER DEFAULT settings, change the entry to NO and press the ENTER button.

## ZONE 2 SETUP Menu

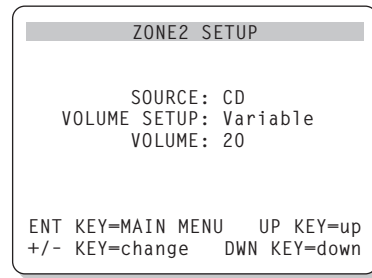

The ZONE 2 SETUP menu provides settings and configuration options related to the operation of Zone 2. This menu is reached by highlighting the ZONE 2 line on the MAIN menu and pressing ENTER.

**SOURCE:** the source selected for listening in Zone 2. Selecting the OFF option turns Zone 2 off.

**VOLUME SETUP:** configures the Zone 2 outputs for VARIABLE or FIXED volume levels. VARIABLE allows control of the volume settings in Zone 2 from the RSX-1055 front-panel or from a remote control/IR repeater in Zone 2. FIXED output disables the Zone 2 volume control. In this mode, the Zone 2 level can be fixed at the level specified on the next line, thus optimizing system performance when sending a fixed level signal to a preamp or amplifier with its own volume adjustment.

**VOLUME:** In VARIABLE output mode, this line shows the current volume setting for Zone 2. In FIXED output mode, this volume setting establishes a permanent fixed output level for Zone 2.

Move the highlight to the desired line using the UP/DOWN buttons and use the +/- buttons to adjust the volume level. To return to the MAIN menu, press the ENTER button. Press the MENU key on the remote to cancel the display and return to normal operation.

# Specifications

## Audio

### Continuous Amplifier Power (five channels driven)

75 watts/ch (20-20k Hz, <0.09% THD, 8 ohms)

### Continuous Amplifier Power (two channels driven)

100 watts/ch (1 kHz, <1.0% THD, 8 ohms, DIN)

### Total Harmonic Distortion

<0.09%

### Intermodulation Distortion (60 Hz:7 kHz)

<0.05%

### Frequency Response

10 Hz - 20 kHz,  $\pm 1$  dB (analog input)

10 Hz - 20 kHz,  $\pm 0.3$  dB (digital input)

### Signal to Noise Ratio (IHF A-weighted)

92 dB (Stereo) Analog

90 dB (Dolby Digital, dts) OdBFs

### Input Sensitivity/Impedance

Line Level: 200 mV/47 kohms

### Tone Controls (Bass/Treble)

$\pm 8$  dB at 100 Hz/10 kHz

### Preamp Output Level

1.2 V (200 mV Input)

## Video

### Frequency Response

3 Hz - 10 MHz,  $\pm 3$  dB

### Signal to Noise Ratio

45 dB

### Input Impedance

75 ohms

### Output Impedance

75 ohms

### Output Level

1 volt

## FM Tuner

### Usable Sensitivity

14.2 dBf

### Signal to Noise Ratio (at 65 dBf)

70 dBf

### Harmonic Distortion (at 65 dBf)

0.03%

### Stereo Separation (1 kHz)

45 dB

### Output level

1 V

### Antenna Input

75 ohms unbalanced

## AM Tuner

### Sensitivity

500  $\mu$ V/m

### Signal to Noise Ratio

40 dBf

### Output level

500 mV

### Antenna Input

Loop Antenna

## General

### Power Consumption:

450 watts

### Power Requirements (AC)

115 volts, 60Hz (USA version)

230 volts, 50Hz (CE version)

### Weight

17 Kg/37.4 lb.

### Dimensions (W x H x D)

432 x 162 x 442 mm

17.01" x 6.38" x 17.40"

### Front Panel Height

(feet removed/for rack mount)

150 mm / 5.91"

**When sizing openings in custom cabinets, measure the exact unit to be installed and/or allow at least 1 mm extra clearance on all sides for unit to unit production tolerances.**

**All specifications are accurate at the time of printing. Rotel reserves the right to make improvements without notice.**

**Rotel and the Rotel HiFi logo are registered trademarks of The Rotel Co, Ltd., Tokyo, Japan.**



**ROTEL**

**The Rotel Co. Ltd.**

10-10 Shinsen-Cho  
Shibuya-Ku  
Tokyo 150-0045  
Japan  
Phone: +81 3-5458-5325  
Fax: +81 3-5458-5310

**Rotel of America**

54 Concord Street  
North Reading, MA 01864-2699  
USA  
Phone: +1 978-664-3820  
Fax: +1 978-664-4109

**Rotel Europe**

Dale Road  
Worthing, West Sussex BN11 2BH  
England  
Phone: +44 (0)1903 221600  
Fax: +44 (0)1903 221525

**Rotel Deutschland**

Kleine Heide 12  
D-33790 Halle/Westf.  
Germany  
Phone: +49 05201-87170  
Fax: +49 05201-73370

**[www.rotel.com](http://www.rotel.com)**